

RHINO VAPI33-ACP

System Board User's Manual

Copyright

This publication contains information that is protected by copyright. No part of it may be reproduced in any form or by any means or used to make any transformation/adaptation without the prior written permission from the copyright holders.

This publication is provided for informational purposes only. The manufacturer makes no representations or warranties with respect to the contents or use of this manual and specifically disclaims any express or implied warranties of merchantability or fitness for any particular purpose. The user will assume the entire risk of the use or the results of the use of this document. Further, the manufacturer reserves the right to revise this publication and make changes to its contents at any time, without obligation to notify any person or entity of such revisions or changes.

All Rights Reserved. © 2000

Trademarks

Microsoft® MS-DOS®, Windows™, Windows® 95, Windows® 98, Windows® 2000 and Windows NT® are registered trademarks of Microsoft Corporation. Intel®, Pentium® III and Celeron™ are registered trademarks of Intel Corporation. VIA Cyrix® III is a registered trademark of VIA Technologies, Inc. Award is a registered trademark of Award Software, Inc. Other trademarks and registered trademarks of products appearing in this manual are the properties of their respective holders.

Caution:

Danger of explosion if battery incorrectly replaced.

Replace only with the same or equivalent type recommended by the manufacturer.

Dispose of used batteries according to the battery manufacturer's instructions.

FCC and DOC Statement on Class B

This equipment has been tested and found to comply with the limits for a Class B digital device, pursuant to Part 15 of the FCC rules. These limits are designed to provide reasonable protection against harmful interference when the equipment is operated in a residential installation. This equipment generates, uses and can radiate radio frequency energy and, if not installed and used in accordance with the instruction manual, may cause harmful interference to radio communications. However, there is no guarantee that interference will not occur in a particular installation. If this equipment does cause harmful interference to radio or television reception, which can be determined by turning the equipment off and on, the user is encouraged to try to correct the interference by one or more of the following measures:

- Reorient or relocate the receiving antenna.
- Increase the separation between the equipment and the receiver.
- Connect the equipment into an outlet on a circuit different from that to which the receiver is connected.
- Consult the dealer or an experienced radio TV technician for help.

Notice:

1. The changes or modifications not expressly approved by the party responsible for compliance could void the user's authority to operate the equipment.
2. Shielded interface cables must be used in order to comply with the emission limits.

Table of Contents

Chapter 1 - Introduction

1.1 Features and Specifications	6
1.2 Package Checklist	10

Chapter 2 - Hardware Installation

2.1 System Board Layout	11
2.2 System Memory	12
2.3 Frequency Ratio Settings for Processors	14
2.4 Jumper Settings for Selecting the CPU Type	15
2.5 Jumper Settings for Selecting the CPU's Front Side Bus	16
2.6 Jumper Settings for Clearing CMOS Data	17
2.7 Jumper Settings for Wake-On-Keyboard/Mouse	18
2.8 Ports and Connectors	19

Chapter 3 - Award BIOS Setup Utility

3.1 The Basic Input/Output System	31
3.1.1 Standard CMOS Setup	31
3.1.2 BIOS Features Setup	34
3.1.3 Chipset Features Setup	38
3.1.4 Power Management Setup	40
3.1.5 PNP/PCI Configuration	44
3.1.6 Load Fail-Safe Settings	46
3.1.7 Load Optimal Settings	46
3.1.8 Integrated Peripherals	46
3.1.9 Supervisor Password	51
3.1.10 User Password	51
3.1.11 IDE HDD Auto Detection	52
3.1.12 Save & Exit Setup	53
3.1.13 Exit Without Saving	53

Chapter 4 - Supported Softwares

4.1 Desktop Management Interface	54
4.2 Hardware Doctor Utility	57
4.3 VIA® Service Pack.....	59
4.4 Drivers and Utilities Installation Notes	60

Appendix A - System Error Messages

A.1 POST Beep	61
A.2 Error Messages	61

Appendix B - Troubleshooting

B.1 Troubleshooting Checklist.....	63
------------------------------------	----

Chapter I - Introduction

I.1 Features and Specifications

I.1.1 Features

Chipset

- VIA® 82C693A and 82C596B (PC-133)

Processor

The system board is equipped with Socket 370 for installing an Intel Celeron™ FCPGA/PPGA, Pentium® III FCPGA or VIA Cyrix® III processor. The system board is also equipped with a switching voltage regulator that supports 1.30V to 2.05V core voltage for various processors.

- Pentium® III FCPGA: 133MHz FSB (533EB-866EB) or 100MHz FSB (500E-800E) processor
- Celeron™ 66MHz FSB: FCPGA (566MHz-600MHz) or PPGA (300A-533MHz) processor
- VIA Cyrix® III 133MHz FSB (PR433/PR500) or 100MHz FSB (PR433/PR466) processor

System Memory

- 16MB to 768MB using VCM (Virtual Channel Memory) or PC SDRAM DIMM (unbuffered or registered)
- Three 168-pin DIMM sockets
- Uses x64 or x72 PC SDRAM, 3.3V
 - PC-66 SDRAM DIMM for 66MHz FSB processors
 - PC-100 SDRAM DIMM for 100MHz FSB processors
 - PC-133 SDRAM DIMM for 133MHz FSB processors
- ECC supported (uses x72 PC SDRAM DIMM)

DIMMs	Memory Size	DIMMs	Memory Size
2MBx64/x72	16MB	16MBx64/x72	128MB
4MBx64/x72	32MB	32MBx64/x72	256MB
8MBx64/x72	64MB		

**Note:**

If you are using more than one DIMM, make sure you insert the same type of DIMMs into the DIMM sockets. Using different types (VCM and PC SDRAM) of DIMMs may cause problems.

Expansion Slots

The system board is equipped with 1 dedicated AGP slot, 3 dedicated PCI slots, 2 dedicated 16-bit ISA slot and 1 shared PCI/ISA slot. All PCI and ISA slots are bus masters.

Desktop Management Interface (DMI)

The system board comes with a DMI 2.0 built into the BIOS. The DMI utility in the BIOS automatically records various information about your system configuration and stores these information in the DMI pool, which is a part of the system board's Plug and Play BIOS. DMI, along with the appropriately networked software, is designed to make inventory, maintenance and troubleshooting of computer systems easier. Refer to Chapter 4 for instructions on using the DMI utility.

ATX double deck ports

- 2 USB ports
- 2 DB-9 serial ports
- 1 DB-25 parallel port
- 1 mini-DIN-6 PS/2 keyboard port
- 1 mini-DIN-6 PS/2 mouse port

Connectors

- 1 connector for IrDA interface
- 2 IDE connectors
- 1 floppy connector
- 1 20-pin ATX power supply connector
- 1 Wake-On-LAN connector
- 1 SB-LINK connector
- 2 fan connectors for CPU and chassis fans

PCI Bus Master IDE Controller

- Two PCI IDE interfaces support up to four IDE devices
- Supports ATA/33 or ATA/66 hard drives
- PIO Mode 3 and Mode 4 Enhanced IDE (data transfer rate up to 16.6MB/sec.)
- Bus mastering reduces CPU utilization during disk transfer
- ATAPI CD-ROM, LS-120 and ZIP supported

IrDA Interface

The system board is equipped with an IrDA connector for wireless connectivity between your computer and peripheral devices. It supports peripheral devices that meet the IrDA or ASKIR standard.

USB Ports

The system board is equipped with two USB ports. USB allows data exchange between your computer and a wide range of simultaneously accessible external Plug and Play peripherals.

BIOS

- Award BIOS, Windows® 95/98 Plug and Play compatible
- Supports SCSI sequential boot-up
- Flash EPROM for easy BIOS upgrades
- Includes NCR 810 SCSI BIOS
- 2MBit flash memory

1.1.2 System Health Monitor Functions

The system board is capable of monitoring the following “system health” conditions.

- Monitors processor/system temperature and processor overheat alarm
- Monitors 1.5V/3.3V/±5V/±12V/V_{CORE} voltages and failure alarm
- Monitors processor/chassis fan speed and failure alarm
- Automatic processor/chassis fan control
- Read back capability that displays temperature, voltage and fan speed

1.1.3 Intelligence

Automatic CPU/Chassis Fan Off

The CPU and chassis fans will automatically turn off once the system enters the Suspend mode.

Dual Function Power Button

Depending on the setting in the BIOS setup, this switch will allow the system to enter the Soft-Off or Suspend mode.

External Modem Ring-on

The Modem Ring-on feature allows the system that is in the Suspend mode or Soft Power Off mode to wake-up/power-on to respond to incoming calls.



Note:

This feature supports external modem only.

RTC Timer to Power-on the System

The RTC installed on the system board allows your system to automatically power-on on the set date and time.

Wake-On-LAN Ready

The Wake-On-LAN function allows the network to remotely wake up a Soft Power Down (Soft-Off) PC. Your LAN card must support the remote wakeup function.



Important:

The 5VSB power source of your power supply must support $\geq 720\text{mA}$ (minimum).

Wake-On-Keyboard/Wake-On-Mouse

This function allows you to use the keyboard or PS/2 mouse to power-on the system. Refer to "Jumper Settings for Wake-On-Keyboard/Wake-On-Mouse" in chapter 2 and "Keyboard/Mouse Power On" in the Integrated Peripherals setup of the Award BIOS in chapter 3 for more information.

**Important:**

- *The power button will not function once a keyboard password has been set in the “KB Power On Password” field of the Integrated Peripherals setup. You must type the correct password to power-on the system.*
- *The 5VSB power source of your power supply must support $\geq 720\text{mA}$ (minimum).*

ACPI

The system board is designed to meet the ACPI (Advanced Configuration and Power Interface) specification. ACPI has energy saving features that enable PCs to implement Power Management and Plug-and-Play with operating systems that support OS Direct Power Management.

Virus Protection

Most viruses today destroy data stored in hard drives. The system board is designed to protect the boot sector and partition table of your hard disk drive.

1.2 Package Checklist

The system board package contains the following items:

- The system board
- A user's manual
- One IDE cable for ATA/33 or ATA/66 hard disk drives
- One 34-pin floppy disk drive cable
- One CD

If any of these items are missing or damaged, please contact your dealer or sales representative for assistance.

Chapter 2 - Hardware Installation

2.1 System Board Layout

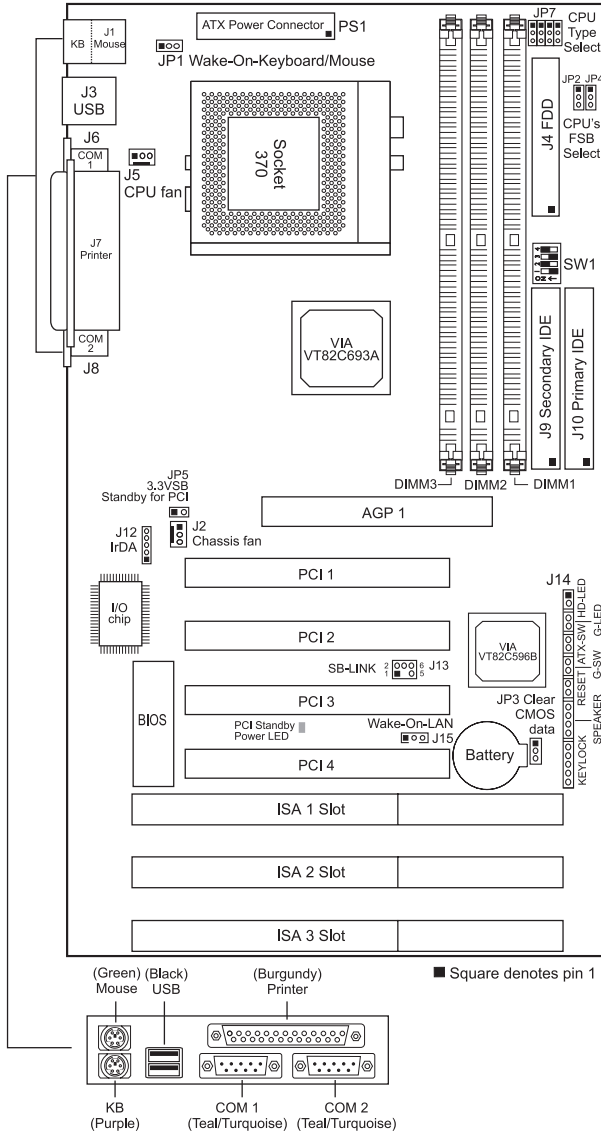

**Warning:**

Electrostatic discharge (ESD) can damage your system board, processor, disk drives, add-in boards, and other components. Perform the upgrade instruction procedures described at an ESD workstation only. If such a station is not available, you can provide some ESD protection by wearing an antistatic wrist strap and attaching it to a metal part of the system chassis. If a wrist strap is unavailable, establish and maintain contact with the system chassis throughout any procedures requiring ESD protection.

2.2 System Memory

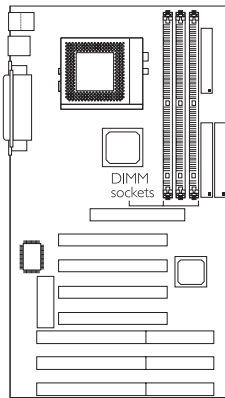

The system board is equipped with three 168-pin DIMM (Dual In-line Memory Module) sockets that support VCM or PC SDRAM DIMM. PC SDRAM (Synchronous Dynamic Random Access Memory) uses a fast memory interface technology that includes using the clock on the chip to synchronize with the CPU clock so that the timing of the memory chips and the timing of the CPU are synchronized. This saves time during transmission of data, subsequently increasing system performance.

The system board also supports the ECC (Error Checking and Correction) function. To use this function, you must install DIMM that supports parity. Refer to chapter 1 (System Memory section) for detailed specification of the memory supported by the system board.

2.2.1 Installing the DIM Module

A DIM module simply snaps into a DIMM socket on the system board. Pin 1 of the DIM module must correspond with Pin 1 of the socket.

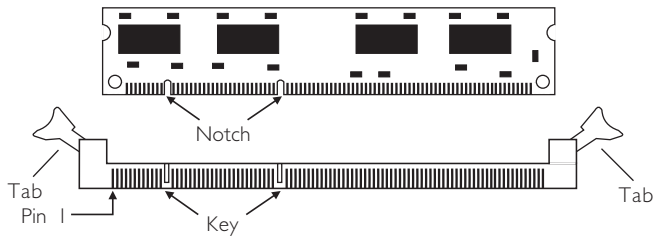

1. Pull the “tabs” which are at the ends of the socket to the side.
2. Position the DIMM above the socket with the “notches” in the module aligned with the “keys” on the socket.
3. Seat the module vertically into the socket. Make sure it is completely seated. The tabs will hold the DIMM in place.

2.3 Frequency Ratio Settings for Processors

We recommend that you use jumper JP7 to select first the type of CPU (Intel® or VIA Cyrix® III) installed on the system board prior to setting its frequency ratio. Refer to the next page for JP7's settings.

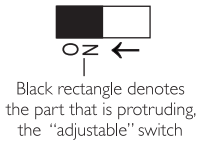

In the example above:

- Switch 1: Off
- Switch 2: On
- Switch 3: Off
- Switch 4: On

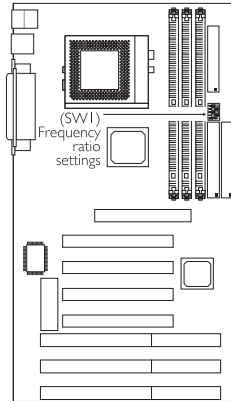

Intel® CPUs

Intel® Processors			Freq. Ratio	SW1	Intel® Processors			Freq. Ratio	SW1
66MHz	100MHz	133MHz			66MHz	100MHz	133MHz		
-----	-----	533MHz	4x		433MHz	650MHz	866MHz	6.5x	
300MHz (300A)	-----	600MHz	4.5x		466MHz	700MHz	Future processor	7x	
333MHz	500MHz	667MHz	5x		500MHz	750MHz	Future processor	7.5x	
366MHz	550MHz	733MHz	5.5x		533MHz	800MHz	Future processor	8x	
400MHz	600MHz	800MHz	6x						

VIA Cyrix® III CPUs

VIA Cyrix® III Processors		Freq. Ratio	SW1	VIA Cyrix® III Processors		Freq. Ratio	SW1
PR433	133MHz			PR433	100MHz		
PR433	133MHz	2.5x		PR433	100MHz	3.5x	
PR500	133MHz	3x		PR466	100MHz	4x	



Important:

- The frequency ratio of some processors shown in the table may have been locked by the manufacturer. If you are using this kind of processor, setting an extended ratio for the processor (using SW1) will have no effect. The system will instead use its factory default ratio.
- The frequency ratio of processors greater than 8x has been locked by the manufacturer and will no longer have the flexibility of using extended ratios. Therefore, the system will use the processor's factory default ratio.
- The processors supported by the system board support VID (Voltage Identification). The switching voltage regulator on the system board will automatically set the voltage regulator according to the voltage of the processor.

2.4 Jumper Settings for Selecting the CPU Type

CPU Type Select - Jumper JP7

This jumper is used to select the type of processor (Intel® or VIA Cyrix® III) installed on the system board.

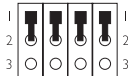
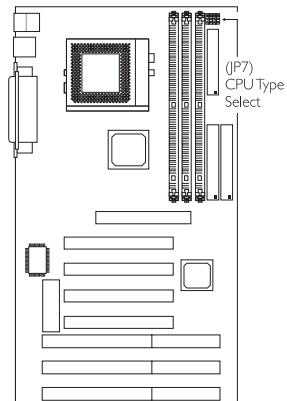

1-2 On:
Intel® CPU
(default)

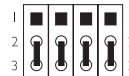

2-3 On:
VIA Cyrix® III CPU

2.5 Jumper Settings for Selecting the CPU's Front Side Bus

CPU's Front Side Bus Select - Jumpers JP2 & JP4

The default setting of jumpers JP2 and JP4 is Auto - the system will automatically run according to the FSB (66/100/133MHz) of the processor.



Warning:

Some processors, when overclocked, may result to the processor's or system's instability and are not guaranteed to provide better system performance. If you are unable to boot your system due to overclocking, make sure to set these jumpers back to their default setting.

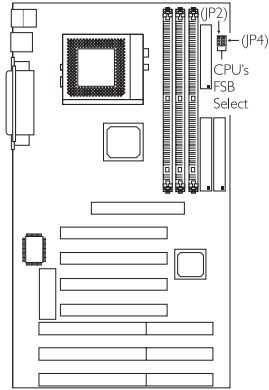

Intel® CPUs

	JP2	JP4
Auto*	1-2 On	1-2 On
66MHz	2-3 On	2-3 On
100MHz	All Off	2-3 On
133MHz	1-2 On	All Off

VIA Cyrix® III CPUs

	JP2	JP4
100MHz	1-2 On	2-3 On
133MHz	1-2 On	1-2 On

**" denotes default setting

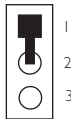

1-2 On



2-3 On



All Off

2.6 Jumper Settings for Clearing CMOS Data

Clear CMOS Data - Jumper JP3

If, for some reason, the CMOS data becomes corrupted or you forgot the supervisor/user/keyboard password, the system can be reconfigured with the default values stored in the ROM BIOS. To load the default values, power off your system and **unplug the power cord**. Set JP3 pins 2 and 3 to On. Wait for a few seconds and set JP3 back to its default setting, pins 1 and 2 On. You may now plug the power cord and power-on your system.

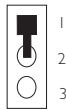
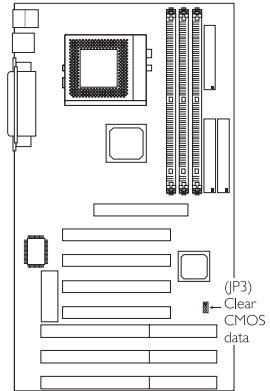

1-2 On: Normal
(default)

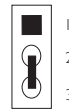

2-3 On:
Clear CMOS Data

2.7 Jumper Settings for Wake-On-Keyboard/ Wake-On-Mouse

Wake-On-Keyboard/Wake-On-Mouse - Jumper JPI

The system board supports the Wake-On-Keyboard/Wake-On-Mouse function. This function allows you to use the keyboard or PS/2 mouse to power-on the system. By default, JPI is disabled. To use this function, set JPI to 2-3 On. "Keyboard/Mouse Power On" in the Integrated Peripherals setup of the Award BIOS must be set accordingly. Refer to chapter 3 for details.

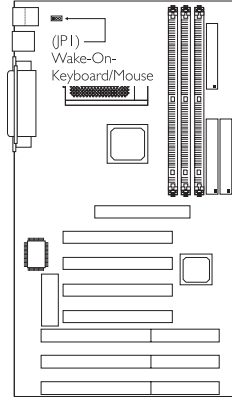

Warning:

1. If JPI was previously enabled with a password set in the "KB Power On Password" field, and now you wish to disable the keyboard password function, make sure to set the "Keyboard/Mouse Power On" field to Disabled prior to setting JPI to disabled. You will not be able to boot up the system if you fail to do so.
2. The power button will not function once a keyboard password has been set in the "KB Power On Password" field of the Integrated Peripherals setup. You must type the correct password to power-on the system.
3. The 5VSB power source of your power supply must support $\geq 720\text{mA}$ (minimum).

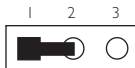

1-2 On: Disable
(default)

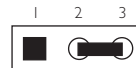

2-3 On: Enable

2.8 Ports and Connectors

2.8.1 Serial Ports

The system board is equipped with onboard serial ports (COM 1: J6 and COM 2: J8) - both in Teal/Turquoise color located at the ATX double deck ports of the board.

These ports are RS-232C asynchronous communication ports with 16C550A-compatible UARTs that can be used with modems, serial printers, remote display terminals, and other serial devices. You can set the serial ports' I/O address in the Integrated Peripherals submenu of the BIOS.

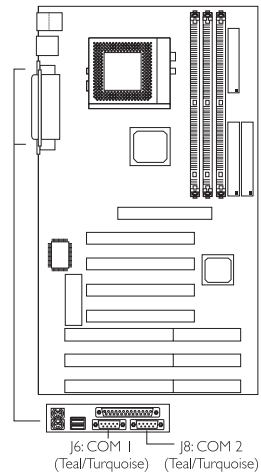

2.8.2 PS/2 Mouse and Keyboard Ports

The system board is equipped with an onboard PS/2 mouse (Green) and PS/2 keyboard (Purple) ports - both at location J1 of the ATX double deck ports. The PS/2 mouse port uses IRQ12. If a mouse is not connected to this port, the system will reserve IRQ12 for other expansion cards.



Warning:

Make sure to turn off your computer prior to connecting or disconnecting a mouse or keyboard. Failure to do so may damage the system board.

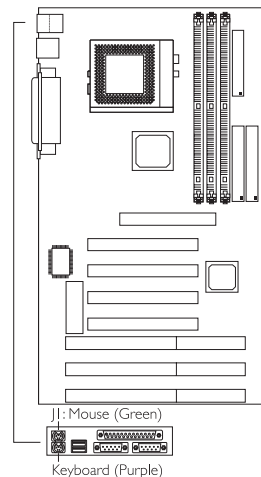

2.8.3 Parallel Ports

The system board has a standard printer port (J7 - Burgundy) located at the ATX double deck ports of the board for interfacing your PC to a parallel printer. It supports SPP, ECP and EPP modes. You can set the port's mode in the Integrated Peripherals submenu of the BIOS.

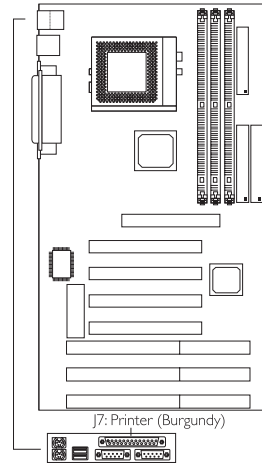

Setting	Function
SPP (Standard Parallel Port)	Allows normal speed operation but in one direction only.
ECP (Extended Capabilities Port)	Allows parallel port to operate in bidirectional mode and at a speed faster than the SPP's data transfer rate.
EPP (Enhanced Parallel Port)	Allows bidirectional parallel port operation at maximum speed.

2.8.4 Floppy Disk Controller

The system board is equipped with a shrouded floppy disk header that supports two standard floppy disk drives. To prevent improper floppy cable installation, the shrouded floppy disk header has a keying mechanism. The 34-pin connector on the floppy cable can be placed into the header only if pin 1 of the connector is aligned with pin 1 of the header. You may enable or disable this function in the Integrated Peripherals setup of the Award BIOS.

Connecting the Floppy Disk Cable

1. Install the 34-pin header connector into the shrouded floppy disk header (J4) on the system board. The colored edge of the ribbon should be aligned with pin 1 of J4.
2. Install the other 34-pin header connector(s) into the disk drive(s). Align the colored edge of the daisy chained ribbon cable with pin 1 of the drive edge connector(s). The end-most connector should be attached to the drive you want to designate as Drive A.

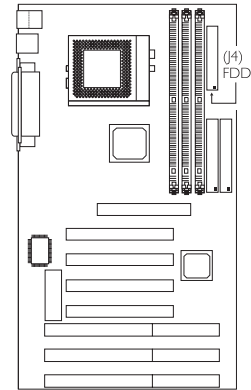

2.8.5 IDE Hard Disk Interface

The system board is equipped with two shrouded PCI IDE headers that will interface four Enhanced IDE (Integrated Drive Electronics) hard disk drives. To prevent improper IDE cable installation, each shrouded PCI IDE header has a keying mechanism. The 40-pin connector on the IDE cable can be placed into the header only if pin 1 of the connector is aligned with pin 1 of the header.

Connecting the Hard Disk Cable

1. If you are connecting two hard drives, install the 40-pin connector of the IDE cable into the primary shrouded IDE header (connector J10). If you are adding a third or fourth IDE device, install the 40-pin connector of the other IDE cable into the secondary shrouded IDE header (connector J9).

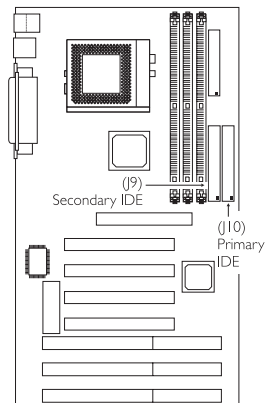

2. Install the other 40-pin header connector(s) into the device with the colored edge of the ribbon cable aligned with pin 1 of the drive edge connector(s).

**Note:**

Refer to your disk drive user's manual for information about selecting proper drive switch settings.

Adding a Second IDE Hard Drive

When using two IDE drives, one must be set as the master and the other as the slave. Follow the instructions provided by the drive manufacturer for setting the jumpers and/or switches on the drives.

We recommend that you use Enhanced IDE or ATA-2, ATA/33 and ATA/66 hard drives be from the same manufacturer. In a few cases, drives from two different manufacturers will not function properly when used together. The problem lies in the hard drives, not the system board.

**Important:**

If you encountered problems while using an ATAPI CD-ROM drive that is set in Master mode, please set the CD-ROM drive to Slave mode. Some ATAPI CD-ROMs may not be recognized and cannot be used if incorrectly set in Master mode.

2.8.6 USB Ports

The system board is equipped with two USB ports (J3 - Black) located at the ATX double deck ports of the board. USB allows data exchange between your computer and a wide range of simultaneously accessible external Plug and Play peripherals. You must have the proper drivers installed in your operating system to use the USB ports. Refer to your operating system's manual or documentation.

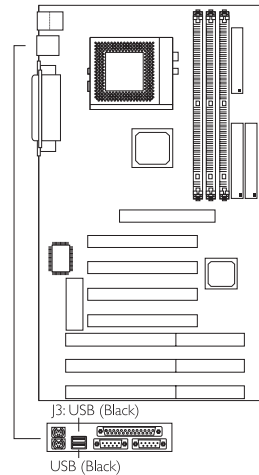

2.8.7 IrDA Connector

The system board is equipped with an IrDA connector for wireless connectivity between your computer and peripheral devices. The IRDA (Infrared Data Association) specification supports data transfers of 115K baud at a distance of 1 meter.

Connect your IrDA cable to connector J12 on the system board. Set "UART2 Mode Select" in the Integrated Peripherals setup of the Award BIOS to the type of IrDA standard supported by your device. You must have the proper drivers installed in your operating system to use this connector. Refer to your operating system's manual or documentation.



Note:

The sequence of the pin functions on some IrDA cable may be reversed from the pin function defined on the system board. Make sure to connect the cable to the IrDA connector according to their pin functions.

Pin	Function
1	VCC
2	N. C.
3	IRRX
4	Ground
5	IRTX

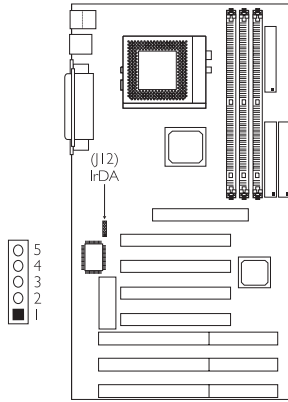

2.8.8 CPU Fan Connector

The processor must be kept cool by using a fan with heatsink. Connect the CPU fan to the 3-pin fan connector at location J5 on the system board.

Pin	Function
1	On/Off
2	+12V
3	Sense

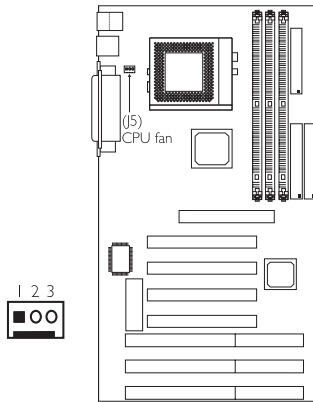

2.8.9 Chassis Fan Connector

The system board is equipped with a chassis fan connector. If you are installing a fan in the system unit, connect the fan's connector to location J2 on the system board. The fan will provide adequate airflow throughout the chassis to prevent overheating the processor.

Pin	Function
1	On/Off
2	+12V
3	Sense

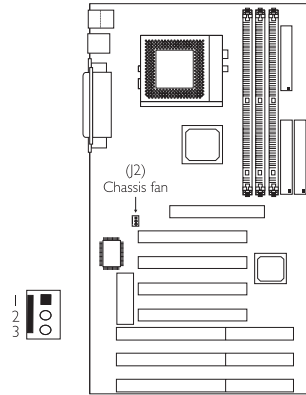

2.8.10 SB-LINK™ Connector

If the system board is installed with a Creative sound card that requires connecting the card to the SB-LINK™ connector; connect the cable that came with the sound card to connector J13. Refer to the sound card's manual for more information.

Pin	Function
1	PC-PCI-GNTx
2	DGND
3	Key
4	PC-PCI-REQx
5	DGND
6	SERIRQ

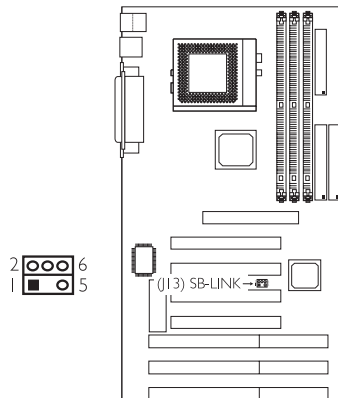

2.8.11 Wake-On-LAN Connector

The system board supports the Wake-On-LAN function. This function will allow the network to remotely power-on a Soft Power Down (Soft-Off) PC. However, if your system is in the Suspend mode, you can power-on the system only through an IRQ or DMA interrupt.

To use the Wake-On-LAN function, you must enable the "Resume on LAN" field in the Power Management Setup of the Award BIOS. Your LAN card package should include a cable. Connect one end of the cable to the wakeup header on the card and the other end to location J15 on the system board. The network will detect Magic Packet and assert a wakeup signal to power-up the system. Refer to the add-in card's manual for details. Note: Your LAN card must support the remote wake up function.

Pin	Function
1	+5VSB (720mA)
2	Ground
3	WOL

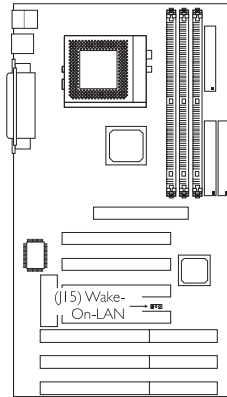

Important:

The 5VSB power source of your power supply must support $\geq 720\text{mA}$ (minimum).

2.8.12 Power Connector

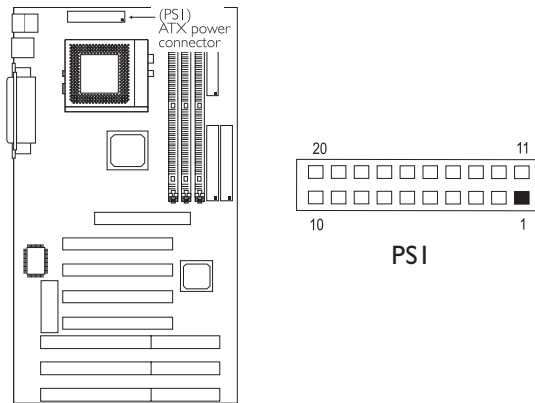

The pin assignment of the ATX power connector is shown below.

Pin	Function	Pin	Function
1	3.3V	11	3.3V
2	3.3V	12	-12V
3	Ground	13	Ground
4	+5V	14	PS-ON
5	Ground	15	Ground
6	+5V	16	Ground
7	Ground	17	Ground
8	PW-OK	18	-5V
9	5VSB	19	+5V
10	+12V	20	+5V



Important:

The system board requires a minimum of 3.3V/6A electric current.

2.8.13 PCI Standby Power LED

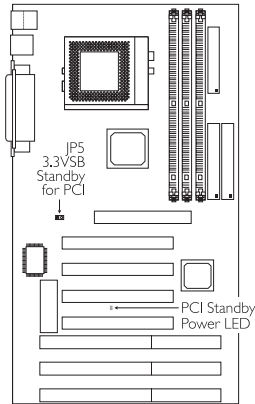

PCI Standby Power LED

This LED will light when the system is in the power-on, Soft-Off or Suspend mode.

3.3VSB Standby for PCI (jumper JP5)

The default setting of jumper JP5 is On. It provides 3.3VSB Standby power to the PCI slots. If you are using a PCI modem card that does not comply to the PCI 2.2 specification, please set this jumper to Off. The PCI Standby Power LED's light will subsequently turn off.



On



Off

**Important:**

Lighted LED serves as a reminder that you must power-off the system then turn off the power supply's switch or unplug the power cord prior to installing any add-on cards.

2.8.14 Front Panel LEDs and Switches

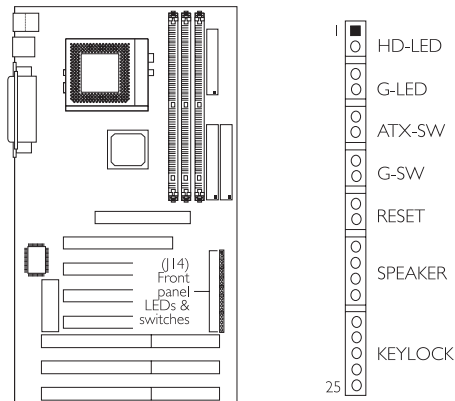

HD-LED: Primary/Secondary IDE LED

This LED will light when the hard drive is being accessed.

G-LED: Green LED

This LED will light when the system is in the Suspend mode.

ATX-SW: ATX Power Switch

Depending on the setting in the BIOS setup, this switch is a “dual function power button” that will allow your system to enter the Soft-Off or Suspend mode. Refer to “Soft-Off By PWR-BTTN” in the Power Management Setup (Chapter 3).

G-SW: Green Switch

This switch will allow your system to enter the Suspend mode.

RESET: Reset Switch

This switch allows you to reboot without having to power off the system thus prolonging the life of the power supply or system.

SPEAKER: Speaker Connector

This connects to the speaker installed in the system chassis.

KEYLOCK: Power/Standby LED and Keylock Connector

Use pins 21-23 to connect to the Power/Standby LED. This LED will light when the system's power is on and blinks when the system enters the Suspend mode. Use pins 24 to 25 to connect to the keyboard lock (located on the front panel of the system chassis) for locking the keyboard.

**Note:**

If a system did not boot-up and the Power/Standby LED did not light after it was powered-on, it may indicate that the CPU or memory module was not installed properly. Please make sure they are properly inserted into their corresponding socket.

	Pin	Pin Assignment
HD-LED (Primary/Secondary IDE LED)	1	HDD LED Power
	2	HDD
	3	N. C.
G-LED (Green LED)	4	Green LED Power
	5	Green
	6	N. C.
ATX-SW (ATX power switch)	7	PWRBT
	8	Ground
	9	N. C.
G-SW (Green switch)	10	SMI
	11	Ground
	12	N. C.
RESET (Reset switch)	13	H/W Reset
	14	Ground
	15	N. C.
SPEAKER (Speaker connector)	16	Speaker Data
	17	N. C.
	18	Ground
	19	Speaker Power
	20	N. C.
KEYLOCK (Keylock and Power/Standby LED connector)	21	LED Power
	22	N.C.
	23	Standby Signal
	24	Keylock
	25	Ground
		Use pins 21 to 23 for the Power/Standby LED.

Chapter 3 - Award BIOS Setup Utility

3.1 The Basic Input/Output System

The Basic Input/Output System (BIOS) is a program that takes care of the basic level of communication between the processor and peripherals. In addition, the BIOS also contain codes for various advanced features found in this system board. This chapter explains the Setup Utility for the Award BIOS.

After you power up your system, the BIOS message appears on your screen and the memory count begins. After the memory test, the following message will appear on the screen:

Press DEL to enter setup

If the message disappears before you respond, restart your system or press the "Reset" button. You may also restart the system by pressing the <Ctrl> <Alt> and keys simultaneously.

When you press , the main program screen will appear:

ROM PCI/ISA BIOS
CMOS SETUP UTILITY
AWARD SOFTWARE, INC.

STANDARD CMOS SETUP BIOS FEATURES SETUP CHIPSET FEATURES SETUP POWER MANAGEMENT SETUP PNP/PCI CONFIGURATION LOAD FAIL-SAFE SETTINGS LOAD OPTIMAL SETTINGS	INTEGRATED PERIPHERALS SUPERVISOR PASSWORD USER PASSWORD IDE HDD AUTO DETECTION SAVE & EXIT SETUP EXIT WITHOUT SAVING
Esc : Quit F10 : Save & Exit Setup	↑↓→← : Select Item (Shift) F2 : Change Color

3.1.1 Standard CMOS Setup

Use the arrow keys to highlight "Standard CMOS Setup" and press <Enter>. A screen similar to the one on the next page will appear:

ROM PCI/ISA BIOS
STANDARD CMOS SETUP
AWARD SOFTWARE, INC.

Date (mm:dd:yy) : Fri, Apr 21 2000									
Time (hh:mm:ss) : 13: 27: 50									
HARD DISKS	TYPE	SIZE	CYLS	HEAD	PRECOMP	LANDZ	SECTOR	MODE	
Primary Master	: Auto	0	0	0	0	0	0	Auto	
Primary Slave	: Auto	0	0	0	0	0	0	Auto	
Secondary Master	: Auto	0	0	0	0	0	0	Auto	
Secondary Slave	: Auto	0	0	0	0	0	0	Auto	
Drive A : 1.44M, 3.5 in.									
Drive B : None									
Video : EGA/VGA								Base Memory : 640K	
Halt on : All Errors								Extended Memory : 64512K	
								Other Memory : 384K	
								Total Memory : 65536K	
Esc : Quit			↑↓→← : Select Item			PU/PD/+/- : Modify			
F10 : Save & Exit Setup			(Shift)F2 : Change						

The settings on the screen are for reference only. Your version may not be identical to this one.

Date

The date format is <day>, <month>, <date>, <year>. Day displays a day, from Sunday to Saturday. Month displays the month, from January to December. Date displays the date, from 1 to 31. Year displays the year, from 1994 to 2079.

Time

The time format is <hour>, <minute>, <second>. The time is based on the 24-hour military-time clock. For example, 1 p.m. is 13:00:00. Hour displays hours from 00 to 23. Minute displays minutes from 00 to 59. Second displays seconds from 00 to 59.

Primary Master, Primary Slave, Secondary Master and Secondary Slave

These categories allow you to enter the appropriate specifications for the type of hard disk drive(s) installed in your system. Press <PgUp> or <PgDn> to select a numbered hard disk type or type the number and press <Enter>. The hard disk will not work properly if you enter improper information for this category. You can use Type "User" to define your own drive type manually. This information should be included in the documentation from your hard disk vendor. If you select Type "Auto", the BIOS will auto-detect the HDD & CD-ROM drive at the POST stage and show the IDE for the HDD & CD-ROM drive. If a hard disk has not been installed, select "None" and press <Enter>.

Drive A and Drive B

These categories identify the types of floppy disk drives installed.

- None* No floppy drive is installed
- 360K, 5.25 in.* 5-1/4 in. standard drive; 360KB capacity
- 1.2M, 5.25 in.* 5-1/4 in. AT-type high-density drive; 1.2MB capacity
- 720K, 3.5 in.* 3-1/2 in. double-sided drive; 720KB capacity
- 1.44M, 3.5 in.* 3-1/2 in. double-sided drive; 1.44MB capacity
- 2.88M, 3.5 in.* 3-1/2 in. double-sided drive; 2.88MB capacity

Video

This category selects the type of video adapter used for the primary system monitor. Although secondary monitors are supported, you do not have to select the type in Setup. The default setting is EGA/VGA (BIOS default, Setup default).

- EGA/VGA* Enhanced Graphics Adapter/Video Graphics Array. For EGA, VGA, SVGA and PGA monitor adapters.
- CGA 40* Color Graphics Adapter. Power up in 40-column mode.
- CGA 80* Color Graphics Adapter. Power up in 80-column mode.
- Mono* Monochrome adapter. Includes high resolution monochrome adapters.

Halt On

This category determines whether the system will stop if an error is detected during power up. The default setting is All Errors (BIOS default, Setup default).

- No Errors* The system boot will not stop for any errors detected.
- All Errors* The system boot will stop whenever the BIOS detects a non-fatal error.
- All, But Keyboard* The system boot will not stop for a keyboard error; it will stop for all other errors.
- All, But Diskette* The system boot will not stop for a disk error; it will stop for all other errors.
- All, But Disk/Key* The system boot will not stop for a disk or keyboard error; it will stop for all other errors.

3.1.2 BIOS Features Setup

The BIOS Features Setup allows you to configure your system for basic operation. Some entries are defaults required by the system board, while others, if enabled, will improve the performance of your system or let you set some features according to your preference.

ROM PCI/ISA BIOS BIOS FEATURES SETUP AWARD SOFTWARE, INC.		
Virus Warning	: Disabled	
CPU L1 Cache	: Enabled	
CPU L2 Cache	: Enabled	
CPU L2 Cache ECC Checking	: Enabled	
Quick Power On Self Test	: Enabled	
Boot Sequence	: A, C, SCSI	
Swap Floppy Drive	: Disabled	
Boot Up Floppy Seek	: Disabled	
Boot Up NumLock Status	: On	
DRAM ECC Checking	: Disabled	
Typeomatic Rate Setting	: Disabled	
Typeomatic Rate (Chars/Sec)	: 6	
Typeomatic Delay (Msec)	: 250	
Security Option	: Setup	ESC : Quit ↑↓←→ : Select Item
PCI/VGA Palette Snoop	: Disabled	F1 : Help PU/PD/+/- : Modify
OS Select For DRAM > 64MB	: Non-OS2	F5 : Old Values (Shift) F2 : Color
HDD S.M.A.R.T. Capability	: Disabled	F6 : Load Fail-Safe Settings
Processor Serial Number	: Disabled	F7 : Load Optimal Settings

The settings on the screen are for reference only. Your version may not be identical to this one.

Virus Warning

This category protects the boot sector and partition table of your hard disk drive. When this item is enabled, the Award BIOS will monitor the boot sector and partition table of the hard disk drive. If an attempt is made to write to the boot sector or partition table of the hard disk drive, the BIOS will halt the system and an error message will appear.

After seeing the error message, if necessary, you will be able to run an anti-virus program to locate and remove the problem before any damage is done.

Many disk diagnostic programs which attempt to access the boot sector table will cause the warning message to appear. If you are running such a program, we recommend that you first disable this category. Also, disable this category if you are installing or running certain operating systems like Windows® 95/98/2000 or the operating system may not install nor work.

CPU L1 Cache and CPU L2 Cache

These categories speed up the memory access. The default value is enabled. Enable the External Cache for better performance.

CPU L2 Cache ECC Checking

By default, ECC is enabled to check the Level 2 cache. If you are not using this function, set this field to Disabled.

Quick Power On Self Test

This category speeds up Power On Self Test (POST) after you power on your system. When Enabled, the BIOS will shorten or skip some check items during POST.

Boot Sequence

This category determines which drive to search first for the disk operating system. The default is A, C, SCSI. The options are:

A, C, SCSI;	C, A, SCSI;	C, CDROM, A;	CDROM, C, A;
D, A, SCSI;	E, A, SCSI;	F, A, SCSI;	SCSI, A, C;
SCSI, C, A;	C only;	LSI/ZIP, C.	

Swap Floppy Drive

When this option is enabled and the system is booting from the floppy drive, the system will boot from drive B instead of drive A. When this option is disabled and the system is booting from the floppy drive, the system will boot from drive A. You must have two floppy drives to use this function.

Boot Up Floppy Seek

When enabled, the BIOS will check whether the floppy disk drive installed is 40 or 80 tracks. When disabled, the BIOS will not check the floppy disk drive.

Boot Up NumLock Status

This allows you to determine the default state of the numeric keypad. By default, the system boots up with NumLock on wherein the function of the numeric keypad is the number keys. When set to Off, the function of the numeric keypad is the arrow keys.

DRAM ECC Checking

If you are using x72 (72-bit) PC SDRAM DIMMs, which are DIMMs that support the ECC (Error Checking and Correction) function, set this field to Enabled.

Typematic Rate Setting

Enable this field to activate the settings in the "Typematic Rate (Chars/Sec)" and "Typematic Delay (Msec)" fields. When this field is set to Disabled, the settings in the following two fields will not take effect.

Typematic Rate (Chars/Sec)

This selection allows you to select the rate at which the keys are accelerated.

Typematic Delay (Msec)

This selection allows you to select the delay between when the key was first depressed and when the acceleration begins.

Security Option

This field determines when the system will prompt for the password - everytime the system boots or only when you enter the BIOS setup. Set the password in the Supervisor/User Password submenu.

- System* The system will not boot and access to Setup will be denied unless the correct password is entered at the prompt.
- Setup* The system will boot, but access to Setup will be denied unless the correct password is entered at the prompt.

PCI/VGA Palette Snoop

It determines whether the MPEG ISA/VESA VGA Cards can work with PCI/VGA or not. The default value is Disabled.

Enabled PCI/VGA working with MPEG ISA/VESA VGA cards.

Disabled PCI/VGA not working with MPEG ISA/VESA VGA cards.

OS Select for DRAM > 64MB

This item allows you to access the memory that is over 64MB in OS/2. The options are: Non-OS/2 and OS/2.

HDD S.M.A.R.T. Capability

The system board supports SMART (Self-Monitoring, Analysis and Reporting Technology) hard drives. SMART is a reliability prediction technology for ATA/IDE and SCSI drives. The drive will provide sufficient notice to the system or user to backup data prior to the drive's failure. The default is Disabled. If you are using hard drives that support S.M.A.R.T., set this field to Enabled. SMART is supported in ATA/33 or later hard drives.

Processor Serial Number

This field will appear only when you are using a Pentium® III or later processor. These processors come with an individual "processor serial number" which by default is activated. Therefore, when connected to the Internet, the processor transmits the serial number online making it possible to track your online activity. The field provides the option of disabling this function.

3.1.3 Chipset Features Setup

ROM PCI/ISA BIOS
CHIPSET FEATURES SETUP
AWARD SOFTWARE, INC.

DIMM 1 DRAM Timing	: Normal	**** System Health Monitor ****
DIMM 2 DRAM Timing	: Normal	Current System Temp. : 28°C/82°F
DIMM 3 DRAM Timing	: Normal	Current CPU Temperature : 42°C/107°F
SDRAM CAS Latency	: 3	Current Chassis FAN Speed : 0 RPM
DRAM Clock	: Host CLK	Current CPU FAN Speed : 4326 RPM
Read Around Write	: Disabled	CPU(V) : 2.00 V
Concurrent PCI/Host	: Disabled	+1.5 V : 1.51 V
CPU to PCI Write Buffer	: Enabled	+3.3 V : 3.40 V
PCI Dynamic Bursting	: Enabled	+5 V : 5.08 V
PCI Master 0 WS Write	: Enabled	+12 V : 12.34 V
PCI Delay Transaction	: Disabled	-12 V : -11.76 V
PCI#2 Access #1 Retry	: Disabled	-5 V : -5.09 V
AGP Master 1 WS Write	: Enabled	ESC : Quit ↑ ↓ → ← : Select Item
AGP Master 1 WS Read	: Disabled	F1 : Help PU/PD/+/- : Modify
Video RAM Cacheable	: Disabled	F5 : Old Values (Shift) F2 : Color
Memory Hole At 15M-16M	: Disabled	F6 : Load Fail-Safe Settings
AGP Aperture Size <MB>	: 64	F7 : Load Optimal Settings
AGP-2X Mode	: Enabled	
CPU/PCI Clock (MHz)	: Default	
Spread Spectrum	: Disabled	

The settings on the screen are for reference only. Your version may not be identical to this one.

This section gives you functions to configure the system based on the specific features of the chipset. The chipset manages bus speeds and access to system memory resources. It also coordinates communications between the conventional ISA bus and the PCI bus. **These items should not be altered unless necessary.** The default settings have been chosen because they provide the best operating conditions for your system. The only time you might consider making any changes would be if you discovered some incompatibility or that data was being lost while using your system.

CPU/PCI Clock (MHz)

This field provides several options for selecting the external system bus clock of the processor. When selecting the external bus clock of your processor, the PCI clock will at the same time appear next to the external bus clock selected. For example, if you selected "66.8/33.4", 66.8MHz is the external bus clock and 33.4MHz is the PCI clock. Regardless of the type of processor used, the default setting is "Default". Under this setting, the system will run according to the processor's clock frequency. If you selected an option other than "Default" and is unable to boot up the system, there are 2 methods of going back to its default setting.

Method 1: Clear the CMOS data by setting JP3 pins 2 and 3 to On. All fields in the BIOS Setup will automatically be set to their default settings.

Method 2: Press the <Insert> key and power button simultaneously, then release the power button first. Keep-on pressing the <Insert> key until the power-on screen appears. This will allow the system to boot according to the FSB of the processor. Now press the key to enter the Award BIOS setup utility. Select "Chipset Features Setup" and set the "CPU/PCI Clock (MHz)" field to "Default" or an appropriate clock frequency.



Note:

- *Selecting an external bus clock other than 66MHz, 100MHz or 133MHz may result to the processor's or system's instability and are not guaranteed to provide better system performance. We recommend that you leave this field to its default setting, which is "Default".*
- *Use a PS/2 or AT (requires a DIN to mini DIN adapter) keyboard for method 2.*
- *When using a 66MHz FSB processor, the AGP clock and the CPU's external bus clock are the same.*
- *When using a 100MHz FSB processor, the AGP clock is 2/3 of the CPU's external bus clock.*
- *When using a 133MHz FSB processor, the AGP clock is 1/2 of the CPU's external bus clock.*

System Health Monitor

The BIOS is capable of monitoring the following system "health" conditions: processor and system temperature, fan speed of the chassis and CPU fans, voltage of the processor and output voltage of the power supply.

- **Current System Temperature, Current CPU Temperature, Current Chassis Fan Speed and Current CPU Fan Speed**

These fields show the internal temperature of the system, current temperature of the processor, and the current fan speed of the chassis and CPU fans in RPM (Revolutions Per Minute).

- CPU(V)

This field shows the voltage of the processor.

- +1.5V, +3.3V, +5V, +12V, -12V and -5V

These fields show the output voltage of the power supply.

3.1.4 Power Management Setup

The Power Management Setup allows you to configure your system to most effectively save energy. If you like to use the soft power down feature of Windows 95/98/2000, you must enable the Power Management below. Select Min. Power, Max. Power or User Defined. Either one can be used as long as it is NOT disabled.

ROM PCI/ISA BIOS POWER MANAGEMENT SETUP AWARD SOFTWARE, INC.		
ACPI Function	: Disabled	** PM Events **
Power Management	: User Define	IRQ3 (COM 2) : Primary
PM Control by APM	: Yes	IRQ4 (COM 1) : Primary
Video Off Method	: DPMS	IRQ5 (LPT 2) : Primary
Video Off After	: Suspend	IRQ6 (Floppy Disk) : Primary
Standby Mode	: Disabled	IRQ7 (LPT 1) : Disabled
Suspend Mode	: Disabled	IRQ8 (RTC Alarm) : Disabled
HDD Power Down	: Disabled	IRQ9 (IRQ2 Redir) : Secondary
Soft-Off by PWR-BTTN	: Instant-Off	IRQ10 (Reserved) : Secondary
PWR Lost Resume State	: Keep Off	IRQ11 (Reserved) : Secondary
Resume on Ring	: Disabled	IRQ12 (PS/2 Mouse) : Secondary
Resume on LAN	: Disabled	IRQ13 (Coprocessor) : Primary
Resume on Alarm	: Disabled	IRQ14 (Hard Disk) : Primary
		IRQ15 (Reserved) : Disabled
		ESC : Quit ↑ ↓ → ← : Select Item
		F1 : Help PU/PD/+/- : Modify
		F5 : Old Values (Shift) F2 : Color
		F6 : Load Fail-Safe Settings
		F7 : Load Optimal Settings

The settings on the screen are for reference only. Your version may not be identical to this one.

ACPI Function

By default, the ACPI function is disabled. This function should be enabled only in operating systems that support ACPI.

Power Management

This category allows you to select the type (or degree) of power saving by changing the length of idle time that elapses before the Standby mode and Suspend mode are activated.

- Disable* No power management. Disables the Standby and Suspend modes.
- Min. Power Saving* Minimum power management. Standby Mode = 1 hr., and Suspend Mode = 1 hr.
- Max. Power Saving* Maximum power management. Standby Mode = 10 sec., and Suspend Mode = 10 sec.
- User Defined* Allows you to set each mode individually. When enabled, each option ranges from 10 sec. to 1 hr.

PM Control by APM

- Yes* An Advanced Power Management device will be activated to enhance the power saving mode and stop the CPU's internal clock. Use this option in Windows® 95/98/2000. (default)
- No* The system BIOS will ignore APM when initiating the Power Management mode.

Video Off Method

This determines the manner in which the monitor is blanked.

- V/H SYNC + Blank* This selection will cause the system to turn off the vertical and horizontal synchronization ports and write blanks to the video buffer.
- Blank Screen* This option only writes blanks to the video buffer.
- DPMS* Initializes display power management signaling. Use this option if your video board supports it.

Video Off After

- N/A* The system BIOS will never turn off the screen.
- Suspend* The screen is off when the system is in the Suspend mode.
- Standby* The screen is off when the system is in the Standby mode.

Standby Mode

This is user configurable only when the Power Management category is set to User Defined. When enabled and after the set time of system inactivity, video will be shut off while all other devices still operate at full speed.

Suspend Mode

This is user configurable only when the Power Management category is set to User Defined. When enabled and after the set time of system inactivity, the CPU and onboard peripherals will be shut off.

HDD Power Down

This is user configurable only when the Power Management category is set to User Defined. When enabled and after the set time of system inactivity, the hard disk drive will be powered down while all other devices remain active.

Soft-Off by PWR-BTTN

This category allows you to select the method of powering off your system.

Hold 4 Sec. Regardless of whether the Power Management field is enabled or disabled, if the power button is pushed and released in less than 4 sec, the system enters the Suspend mode. The purpose of this function is to prevent the system from powering off in case you accidentally "hit" or pushed the power button. Push and release again in less than 4 sec to restore. Pushing the power button for more than 4 seconds will power off the system.

Instant-Off Pressing and then releasing the power button at once will immediately power off your system.

PWR Lost Resume State

Keep Off When power returns after an AC power failure, the system's power is off. You must press the Power button to power-on the system.

Turn On When power returns after an AC power failure, the system will automatically power-on.

Last State When power returns after an AC power failure, the system will return to the state where you left off before power failure occurs. If the system's power is off when AC power failure occurs, it will remain off when power returns. If the system's power is on

when AC power failure occurs, the system will power-on when power returns.

Resume On Ring

With an external modem installed, the Modem Ring-on function will allow your system to power-on to respond to incoming calls. By default, the "Resume on Ring" field is Disabled. To use this function, please follow the steps below.

1. Make sure the computer system is powered off.
2. Connect the external modem to the COM 1 or COM 2 serial port.
3. Switch on the power of the external modem.
4. Power-on the computer system. After the memory test, press to enter the Award BIOS setup utility.
5. Select Power Management Setup and press <Enter>.
6. Enable the "Resume on Ring" field.
7. Press <Esc> to return to the main menu of the Award BIOS setup utility. Select "Save & Exit Setup" and press <Enter>.
8. Type <Y> and press <Enter>.

Resume On LAN

With a LAN card installed, the Wake-On-LAN function allows the network to remotely wake up a Soft Power Down (Soft-Off) PC. However, if your system is in the Suspend mode, you can wake-up the system only through an IRQ or DMA interrupt. Make sure your LAN card supports the remote wakeup function. To use this function, set this field to Enabled. Refer to the "Wake-On-LAN Connector" section in chapter 2 of this manual for more information.

Resume On Alarm

Enabled When Enabled, you can set the date and time you would like the Soft Power Down (Soft-Off) PC to power-on. However, if the system is being accessed by incoming calls or the network (Resume On Ring/LAN) prior to the date and time set in this field, the system will give priority to the incoming calls or

network. "Date (of Month)" and "Timer (hh:mm:ss)" will appear right below this field.

Disabled Disables the automatic power-on function. (default)

Date (of Month)

0 The system will power-on everyday according to the time set in the "Timer (hh:mm:ss)" field.

1-31 Select a date you would like the system to power-on. The system will power-on on the set date, and time set in the "Timer (hh:mm:ss)" field.

Timer (hh:mm:ss)

This is used to set the time you would like the system to power-on.

PM Events

When enabled, the specified IRQ interrupt will cause the system to wake up completely from the power management mode. When disabled, the system will not wake up from the power management mode in spite of the IRQ interrupt.

3.1.5 PNP/PCI Configuration

This section describes configuring the PCI bus system. It covers some very technical items and it is strongly recommended that only experienced users should make any changes to the default settings.

ROM PCI/ISA BIOS PNP/PCI CONFIGURATION AWARD SOFTWARE, INC.			
Resources Controlled By	: Auto	Assign IRQ for VGA	: Enabled
Reset Configuration Data	: Disabled	PCI Slot 1 Use IRQ	: Auto
		PCI Slot 2 Use IRQ	: Auto
		PCI Slot 3 Use IRQ	: Auto
		PCI Slot 4 Use IRQ	: Auto
		ESC : Quit	↑ ↓ → ← : Select Item
		F1 : Help	PU/PD/+/- : Modify
		F5 : Old Values (Shift)	F2 : Color
		F6 : Load Fail-Safe Settings	
		F7 : Load Optimal Settings	

The settings on the screen are for reference only. Your version may not be identical to this one.

Resources Controlled By

The Award Plug and Play BIOS has the capability to automatically configure all of the boot and Plug and Play compatible devices.

- Auto* The system will automatically detect the settings for you. The categories that follow will not be shown on the screen.
- Manual* This will allow you to set the IRQ/DMA (you have assigned your add-in card) to Legacy ISA or PCI/ISA PnP. For non-PnP ISA cards, select Legacy ISA. For PnP ISA or PCI cards, select PCI/ISA PnP.

Reset Configuration Data

- Enabled* The BIOS will reset the configuration data once automatically. It will then recreate a new set of configuration data.
- Disabled* The BIOS will not reset the configuration data.

Assign IRQ for VGA

When Enabled, the system automatically assigns an IRQ for the VGA card installed. Your VGA card will need an IRQ only when using the video capture function of the card. If you are not using this function and a new device requires an IRQ, you can set this function to Disabled. The IRQ (previously occupied by the VGA card) will be available for your new device.



Note:

When Disabled, a "Yellow" mark will appear in Windows® 95/98's Device Manager.

PCI Slot 1 Use IRQ to PCI Slot 4 Use IRQ

By default, an IRQ is automatically assigned to each PCI slot. You may also manually assign an IRQ to these slots. The options are: 3, 4, 5, 7, 9, 10, 11, 12, 14 and 15.

3.1.6 Load Fail-Safe Settings

The "Load Fail-Safe Settings" option loads the troubleshooting default values permanently stored in the ROM chips. These settings are not optimal and turn off all high performance features. You should use these values only if you have hardware problems. Highlight this option on the main menu and press <Enter>. The message below will appear:

Load Fail-Safe Settings (Y/N)? N

If you want to proceed, type <Y> and press <Enter>. The default settings will be loaded.

3.1.7 Load Optimal Settings

The "Load Optimal Settings" option loads optimized settings from the BIOS ROM. Use the Setup default values as standard values for your system. Highlight this option on the main menu and press <Enter>. The message below will appear:

Load Optimal Settings (Y/N)? N

Type <Y> and press <Enter> to load the Setup default values.

3.1.8 Integrated Peripherals

ROM PCI/ISA BIOS
INTEGRATED PERIPHERALS
AWARD SOFTWARE, INC.

Onboard Primary PCI IDE	: Enabled	KBC Input Clock	: 8MHz
Onboard Secondary PCI IDE	: Enabled	Onboard FDC Controller	: Enabled
IDE Prefetch Mode	: Enabled	Onboard Serial Port 1	: 3F8/IRQ4
IDE HDD Block Mode	: Enabled	Onboard Serial Port 2	: 2F8/IRQ3
IDE Primary Master PIO	: Auto	UART2 Mode Select	: Normal
IDE Primary Slave PIO	: Auto		
IDE Secondary Master PIO	: Auto	Onboard Parallel Port	: 378/IRQ7
IDE Secondary Slave PIO	: Auto	Parallel Port Mode	: ECP+EPP
IDE Primary Master UDMA	: Auto	ECP Mode Use DMA	: 3
IDE Primary Slave UDMA	: Auto	EPP Mode Select	: EPP1.7
IDE Secondary Master UDMA	: Auto	Keyboard/Mouse Power On	: Disabled
IDE Secondary Slave UDMA Init:	Auto		
Display First	: AGP	ESC : Quit	↑ ↓ → ← : Select Item
USB Controller	: Enabled	F1 : Help	PU/PD+/- : Modify
USB Keyboard Support	: Disabled	F5 : Old Values (Shift) F2	: Color
		F6 : Load Fail-Safe Settings	
		F7 : Load Optimal Settings	

The settings on the screen are for reference only. Your version may not be identical to this one.

Onboard Primary PCI IDE and Onboard Secondary PCI IDE

These categories allow you to enable or disable the primary and secondary IDE controller. The default is Enabled. Select Disabled if you want to add a different hard drive controller.

IDE Prefetch Mode

This allows data and addresses to be stored in the internal buffer of the chip, thus reducing access time. Enable this field to achieve better performance.

IDE HDD Block Mode

Enabled The IDE HDD uses the block mode. The system BIOS will check the hard disk drive for the maximum block size the system can transfer. The block size will depend on the type of hard disk drive.

Disabled The IDE HDD uses the standard mode.

IDE Primary Master/Slave PIO and IDE Secondary Master/Slave PIO

PIO means Programmed Input/Output. Rather than have the BIOS issue a series of commands to effect a transfer to or from the disk drive, PIO allows the BIOS to tell the controller what it wants and then let the controller and the CPU perform the complete task by themselves. Your system supports five modes, 0 (default) to 4, which primarily differ in timing. When Auto is selected, the BIOS will select the best available mode after checking your drive.

Auto The BIOS will automatically set the system according to your hard disk drive's timing.

0-4 You can select a mode that matches your hard disk drive's timing. Caution: Do not use the wrong setting or you will have drive errors.

IDE Primary Master/Slave UDMA and IDE Secondary Master/Slave UDMA

These categories allow you to set the Ultra DMA in use. When Auto is selected, the BIOS will select the best available option after checking your hard drive or CD-ROM.

- Auto* The BIOS will automatically detect the settings for you.
- Disabled* The BIOS will not detect these categories.

Init Display First

This field is used to select whether to initialize AGP or PCI first when the system boots.

- AGP* When the system boots, it will first initialize AGP.
- PCI Slot* When the system boots, it will first initialize PCI.

USB Controller

We recommend that you leave this field in its default setting - Enabled.

USB Keyboard Support

By default, USB Keyboard Support is Disabled. However, if you are using a USB keyboard under DOS, make sure to enable this function.

KBC Input Clock

This is used to select the input clock of your keyboard. The options are: 8MHz and 12MHz. The default is 8MHz.

Onboard FDC Controller

- Enabled* Enables the onboard floppy disk controller.
- Disabled* Disables the onboard floppy disk controller.

Onboard Serial Port 1 and Onboard Serial Port 2

- Auto* The system will automatically select an I/O address for the onboard serial port 1 and serial port 2.
- 3F8/IRQ4, 2F8/IRQ3, 3E8/IRQ4, 2E8/IRQ3* Allows you to manually select an I/O address for the onboard serial port 1 and serial port 2.

Disabled Disables the onboard serial port 1 and/or serial port 2.

UART2 Mode Select

The system board supports IrDA function for wireless connectivity between your computer and peripheral devices. You may not use IrDA (J12) and the COM 2 serial port (J8) at the same time. If you are using the COM 2 serial port, make sure “UART2 Mode Select” is set to Normal.

To use the IrDA function, follow the steps below.

1. Connect your IrDA cable to connector J12 on the system board.
2. Set “UART2 Mode Select” to the type of IrDA standard supported by your IrDA peripheral/device (IrDA 1.0 or ASKIR). For better transmission of data, your IrDA peripheral device must be within a 30° angle and within a distance of 1 meter.
3. The following will appear right after “UART2 Mode Select”.

IR Transmission Delay

If this option is Enabled, transmission of data will be slower. This is recommended when you encounter transmission problem with your device. The options are: Enabled and Disabled.

Onboard Parallel Port

378H//IRQ7, 3BCH//IRQ7, 278H//IRQ5 Selects the I/O address and IRQ for the onboard parallel port.

Disabled Disables the onboard parallel port.

Parallel Port Mode, ECP Mode Use DMA and EPP Mode Select

These fields will appear only if you selected an I/O address and IRQ in the Onboard Parallel Port field. These apply to a standard specification and will depend on the type and speed of your device. Refer to your peripheral's manual for the best option.

The parallel modes are SPP, EPP, ECP and ECP+EPP. The default is ECP+EPP. Both “ECP Mode Use DMA” and “EPP Mode Select” will appear on the screen. If you selected EPP, “EPP Mode Select” will appear. This field applies to standard specification. The options are EPPI.9 and EPPI.7. Default setting: EPPI.7. If you selected ECP, “ECP Mode Use DMA” will appear. This is used to select a DMA channel for the parallel port. The options are 1 and 3. Default setting: 3.

Keyboard/Mouse Power On

This field allows you to use the keyboard or mouse to power-on the system. To use this function, make sure JPI is set to 2-3 On - the Wake-On-Keyboard/Mouse function enabled. Refer to “Jumper Settings for Wake-On-Keyboard/Wake-On-Mouse” in Chapter 2 of this manual for more information.

Disabled

Default setting.



Warning:

If JPI was previously enabled with a password set in the “KB Power On Password” field, and now you wish to disable the keyboard password function, make sure to set this field to disabled prior to setting JPI to disabled (1-2 On). You will not be able to boot up the system if you fail to do so.

Password

When this option is selected, the “KB Power On Password” field will appear. Move the cursor to this field and press <Enter>. Enter your password. You can enter up to 5 characters. Type in exactly the same password to confirm, then press <Enter>.



Important:

The power button will not function once a keyboard password has been set in the “KB Power On Password” field. You must type the correct password to power-on the system.

Hot Key

When this option is selected, the “KB Power On Hot Key” field will appear. Move the cursor to this field to select a function key you would like to use to power-on the system. The options are from Ctrl-F1 to Ctrl-F12.

- Mouse Left* When this option is selected, double-click the left button of the mouse to power-on the system.
- Mouse Right* When this option is selected, double-click the right button of the mouse to power-on the system.
- Any Key* Press any key to power-on the system.
- Keyboard 98* When this option is selected, press the “wake up” key of the Windows® 98 compatible keyboard to power-on the system.

3.1.9 Supervisor Password

If you want to protect your system and setup from unauthorized entry, set a supervisor’s password with the “System” option selected in the BIOS Features Setup. If you want to protect access to setup only, but not your system, set a supervisor’s password with the “Setup” option selected in the BIOS Features Setup.

Use the arrow keys to highlight the “Supervisor Password” option and press <Enter>. The message below will appear:

Enter Password:

Type in the password. You are limited to eight characters. When done, the message below will appear:

Confirm Password:

You are asked to verify the password. Type in exactly the same password. If you type in a wrong password, you will be prompted to enter the correct password again. To delete or disable the password function, highlight “Supervisor Password” and press <Enter>. Instead of typing in a new password, press the <Enter> key, and then press any key to return to the main menu.

3.1.10 User Password

If you want another user to have access only to your system but not to setup, set a user’s password. Using user’s password to enter Setup allows a user to access only the “User Password” option that appears on the main screen. Access to all other options is denied. To set, confirm, verify, disable or delete a user’s password, follow the procedures described in the “Supervisor Password” section.

3.1.11 IDE HDD Auto Detection

Use this option to detect the parameters for the hard disk drives installed in your system. These parameters will then be automatically entered into the "Standard CMOS Setup". The IDE HDD Auto Detection screen displays the following categories of information: Size, Cylinders, Heads, Precomp, LandZone, Sectors and Mode.

ROM PCI/ISA BIOS
CMOS SETUP UTILITY
AWARD SOFTWARE, INC.

HARD DISKS	TYPE	SIZE	CYLS	HEAD	RECOMP	LANDZ	SECTOR	MODE
Primary Master:								
Select Primary Master Option (N=Skip): N								
OPTIONS	SIZE	CYLS	HEAD	RECOMP	LANDZ	SECTOR	MODE	
2 (Y)	853	827	32	0	1653	63	LBA	
1	853	1654	16	65535	1653	63	Normal	
3	853	827	32	65536	1653	63	Large	
Note: Some OS (like SCO-UNIX) must be "NORMAL" for installation								
ESC: Skip								

The settings on the screen are for reference only. Your version may not be identical to this one.

For hard drives larger than 528MB, you would typically select the LBA type. Certain operating systems require that you select Normal or Large. Please check your operating system's manual or Help desk on which one to select.

3.1.12 Save & Exit Setup

When all the changes have been made, highlight “Save & Exit Setup” and press <Enter>. The message below will appear:

Save to CMOS and Exit (Y/N)? N

Type “Y” and press <Enter>. The modifications you have made will be written into the CMOS memory, and the system will reboot. You will once again see the initial diagnostics on the screen. If you wish to make additional changes to the setup, press <Ctrl> <Alt> <Esc> simultaneously or after memory testing is done.

3.1.13 Exit Without Saving

When you do not want to save the changes you have made, highlight “Exit Without Saving” and press <Enter>. The message below will appear:

Quit Without Saving (Y/N)? N

Type “Y” and press <Enter>. The system will reboot and you will once again see the initial diagnostics on the screen. If you wish to make any changes to the setup, press <Ctrl> <Alt> <Esc> simultaneously or after memory testing is done.

Chapter 4 - Supported Softwares

4.1 Desktop Management Interface (DMI)

The system board comes with a DMI built into the BIOS. DMI, along with the appropriately networked software, is designed to make inventory, maintenance and troubleshooting of computer systems easier. With DMI, a network administrator or MIS engineer can remotely access some information about a particular computer system without physically going to it. Quite often a service call may be unnecessary as the problem can be solved remotely.

The DMI utility in the BIOS automatically records various information about your system configuration. Information about the type and speed of CPU, type and amount of memory for each memory slot, BIOS revision level, types of add-in PCI boards and components, certain revision numbers of hardware installed, etc. are automatically detected and stored in the DMI pool, which is a part of the system board's Plug and Play BIOS. Additional information, such as ISA based peripherals, which may not be automatically detected, can be manually recorded in the DMI pool by using the Add DMI menu. The DMI pool data is then verified or updated whenever the system hardware or setup is altered.

4.1.1 Running the DMI Utility

To run the DMI utility, type: DMICFG.EXE. Please contact your sales representative for the utility.

The DMI utility must run in real mode with at least 180K of base memory. Memory managers like HIMEM.SYS (required by Windows) must not be installed. You may do this by using one of the 3 methods listed below.

1. Boot up from a system diskette without the AUTOEXEC.BAT and CONFIG.SYS files,
2. "REM" HIMEM.SYS in the CONFIG.SYS, or
3. Press <F5> during bootup to bypass your AUTOEXEC.BAT and CONFIG.SYS files.

4.1.2 Using the DMI Utility

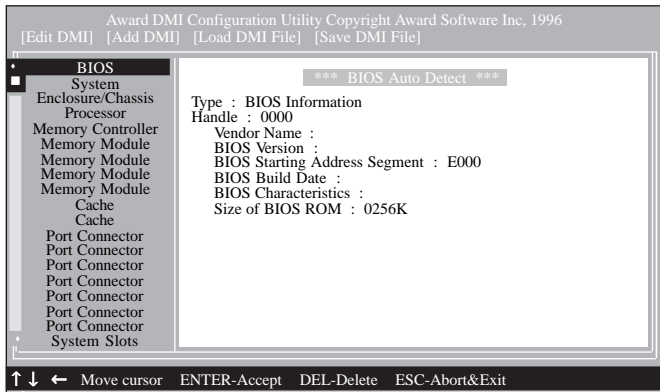

The four menus located on top of the DMI Configuration Utility screen are Edit DMI, Add DMI, Load DMI File and Save DMI File. Use the ← or → (left or right) arrow keys to select a menu from the Menu bar.

On the left side of the screen is a list of the system configuration items. Use the ↑ or ↓ (up or down) arrow keys to select an item.

The commands at the bottom of the screen will allow you to navigate through the various setup menus.

Edit DMI

1. Use the ← or → arrow keys to select the Edit DMI menu.
2. Highlight the item on the left screen that you would like to edit by using the ↑ or ↓ arrow keys, then press <Enter>.
3. The cursor will move to the screen you select allowing you to edit information. The screen will also display the auto-detected information.
4. Press <F10> to update the edited information into the flash ROM.

Add DMI

1. Use the ← or → arrow keys to select the Add DMI menu.
2. Highlight the item on the left screen that you would like to add by using the ↑ or ↓ arrow keys, then press <Enter>.
3. The cursor will move to the screen you select allowing you to enter information about the added item.
4. Press <F10> to save information into the flash ROM.

To view information about the added items, go to the Edit DMI menu.

Load DMI File

1. Use the ← or → arrow keys to select the Load DMI File menu.
2. The following message will appear:

Press [Enter] to select DMI file for load

Press <Enter>.

3. The DMI files will appear on the screen. Select the file you would like to load and press <Enter>.
4. The following message will appear:

Do you want to execute? (Y/N)

Type <Y>. All previous DMI structures will be destroyed and the new file will be saved into the flash ROM.

Save DMI File

1. Use the ← or → arrow keys to select the Save DMI File menu.
2. The following message will appear:

Press [Enter] to select DMI file for save

Press <Enter>.

3. Enter the directory and filename under which you would like the DMI file saved.

4.2 Hardware Doctor Utility

The system board comes with a Hardware Doctor utility contained in the provided CD. This utility is capable of monitoring the system's "health" conditions and allows you to manually set a range (Highest and Lowest Limit) to the items being monitored. If the settings/values are over or under the set range, a warning message will pop-up. The utility can also be configured so that a beeping alarm will sound whenever an error occurs. We recommend that you use the "Default Setting" which is the ideal setting that would keep the system in good working condition.



Note:

Use this utility only in Windows® 95, Windows® 98 and Windows NT® 4.0.

To install the utility, insert the CD (included in the system board package) into a CD-ROM drive. The autorun screen will appear. Double-click the Hardware Doctor icon to install the utility. After installing the utility, the screen below will appear.



(Click here for a clearer view of the screen)

The rightmost column of the screen shows the current value of each monitored item. To set the highest and lowest limit of each item, click on the arrow buttons in the "Lowest Limit" or "Highest Limit" column. However, we **DO NOT** recommend that you change the settings of the Voltages. Make sure to leave them in their default setting.

To further configure the utility, select "Configuration" in the Tools menu. The Monitoring Config. screen will appear:

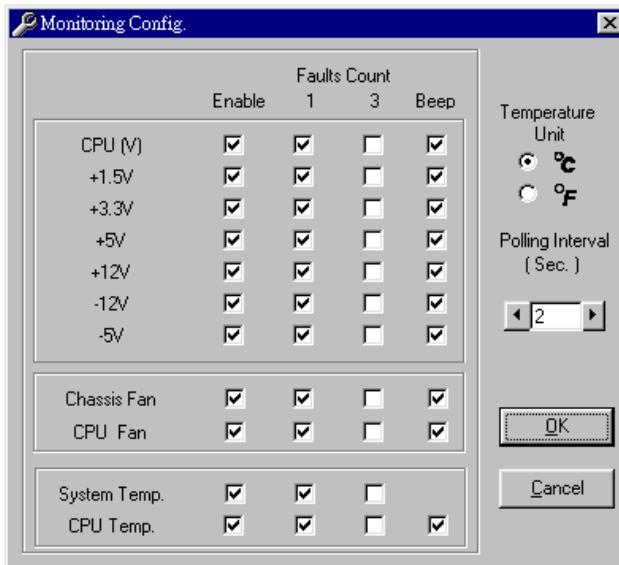

(Click here for a clearer view of the screen)

Enable

Click on the items you want to be monitored.

Faults Count (1 or 3)

This allows you to select the number of fault counts detected before a warning message pop-up. "1" = The warning message will pop-up once an error has been detected. "3" = The warning message will pop-up after the error has been detected thrice.

Beep

Besides the pop-up warning message, you can choose to enable the beep alarm so that if an abnormal condition occurs, an alarm will sound. Due to its hardware limitation, the only item that cannot be enabled is "System Temp". If the internal temperature of the system is too high, only a warning message will pop-up.

Temperature Unit

You can select the temperature unit between Celsius and Fahrenheit. The default unit is Celsius.

Polling Interval

This is used to set the interval for monitoring the system. The range is from 1 sec. to 120 sec. The default interval is 2 sec.

4.3 VIA® Service Pack

The CD in the system board package also comes with the VIA® Service Pack. The service pack includes the following drivers.

- Default IDE DMA Mode Setting
- AGP VxD Driver
- VIA Chipset Functions' Registry
- VIA PCI IRQ Miniport Driver

To install the drivers, insert the CD into a CD-ROM drive. The autorun screen (Main Board Utility CD) will appear. Click the VIA Service Pack button. For installation instructions or information, click the "Read Me" button in the autorun screen.

4.3.1 VIA® Service Pack Installation Notes

"VIA Service Pack" in the provided CD includes the "AGP VxD Driver" and "VIA Chipset Functions' Registry" drivers. These drivers are supported in Windows® 95, Windows® 98 and Windows® 98 second edition.

You must first install VIA® Service Pack prior to installing any other drivers. However, this may not be the case for some AGP cards. Please read carefully the information below.



Important:

The VGA driver that came with some AGP cards (Asus, Leadtek, etc) is already bundled with the AGP VxD driver. Since the version of the bundled VxD driver may be older than the one provided in the CD, installing the bundled VxD driver may cause problems. If you are using this type of card, we recommend that you install first the AGP card's VGA driver before installing the VIA Service Pack.

To install the VIA Service pack, please follow the steps below.

1. Insert the CD that came with the system board package into a CD-ROM drive. The autorun screen (Main Board Utility CD) will appear.
2. Click "VIA Service Pack".
3. The "Welcome" screen will appear. Click "Next". Please read the "VIA Service Pack readme" carefully before proceeding to step 4.
4. Follow the prompts on the screen to complete the installation.
5. Reboot the system for the drivers to take effect.

4.4 Drivers and Utilities Installation Notes

1. "Autorun" ONLY supports the Windows® 95, Windows® 98, Windows® 2000 and Windows NT® 4.0 operating systems. If after inserting the CD, "Autorun" did not automatically start (which is, the Main Board Utility CD screen did not appear), please go directly to the root directory of the CD and double-click "Autorun".
2. All steps or procedures to install software drivers are subject to change without notice as the softwares are occasionally updated. Please refer to the readme files, if available, for the latest information.

Appendix A - System Error Message

When the BIOS encounters an error that requires the user to correct something, either a beep code will sound or a message will be displayed in a box in the middle of the screen and the message, PRESS F1 TO CONTINUE, CTRL-ALT-ESC or DEL TO ENTER SETUP, will be shown in the information box at the bottom. Enter Setup to correct the error.

A.1 POST Beep

There are two kinds of beep codes in the BIOS. One code indicates that a video error has occurred and the BIOS cannot initialize the video screen to display any additional information. This beep code consists of a single long beep followed by three short beeps. The other code indicates that a DRAM error has occurred. This beep code consists of a single long beep.

A.2 Error Messages

One or more of the following messages may be displayed if the BIOS detects an error during the POST. This list indicates the error messages for all Awards BIOSes:

CMOS BATTERY HAS FAILED

The CMOS battery is no longer functional. It should be replaced.



Caution:

Danger of explosion if battery incorrectly replaced. Replace only with the same or equivalent type recommended by the manufacturer. Dispose of used batteries according to the battery manufacturer's instructions.

CMOS CHECKSUM ERROR

Checksum of CMOS is incorrect. This can indicate that CMOS has become corrupt. This error may have been caused by a weak battery. Check the battery and replace if necessary.

DISPLAY SWITCH IS SET INCORRECTLY

The display switch on the motherboard can be set to either monochrome or color. This indicates the switch is set to a different

setting than indicated in Setup. Determine which setting is correct, either turn off the system and change the jumper or enter Setup and change the VIDEO selection.

FLOPPY DISK(S) fail (80)

Unable to reset floppy subsystem.

FLOPPY DISK(S) fail (40)

Floppy type mismatch.

Hard Disk(s) fail (80)

HDD reset failed.

Hard Disk(s) fail (40)

HDD controller diagnostics failed.

Hard Disk(s) fail (20)

HDD initialization error.

Hard Disk(s) fail (10)

Unable to recalibrate fixed disk.

Hard Disk(s) fail (08)

Sector Verify failed.

Keyboard is locked out - Unlock the key

The BIOS detects that the keyboard is locked. Keyboard controller is pulled low.

Keyboard error or no keyboard present

Cannot initialize the keyboard. Make sure the keyboard is attached correctly and no keys are being pressed during the boot.

Manufacturing POST loop

System will repeat POST procedure infinitely while the keyboard controller is pull low. This is also used for the M/B burn in test at the factory.

BIOS ROM checksum error - System halted

The checksum of ROM address F0000H-FFFFFFH is bad.

Memory test fail

The BIOS reports memory test fail if the memory has error(s).

Appendix B - Troubleshooting

B.1 Troubleshooting Checklist

This chapter of the manual is designed to help you with problems that you may encounter with your personal computer. To efficiently troubleshoot your system, treat each problem individually. This is to ensure an accurate diagnosis of the problem in case a problem has multiple causes.

Some of the most common things to check when you encounter problems while using your system are listed below.

1. The power switch of each peripheral device is turned on.
2. All cables and power cords are tightly connected.
3. The electrical outlet to which your peripheral devices are connected is working. Test the outlet by plugging in a lamp or other electrical device.
4. The monitor is turned on.
5. The display's brightness and contrast controls are adjusted properly.
6. All add-in boards in the expansion slots are seated securely.
7. Any add-in board you have installed is designed for your system and is set up correctly.

Monitor/Display

If the display screen remains dark after the system is turned on:

1. Make sure that the monitor's power switch is on.
2. Check that one end of the monitor's power cord is properly attached to the monitor and the other end is plugged into a working AC outlet. If necessary, try another outlet.
3. Check that the video input cable is properly attached to the monitor and the system's display adapter.
4. Adjust the brightness of the display by turning the monitor's brightness control knob.

The picture seems to be constantly moving.

1. The monitor has lost its vertical sync. Adjust the monitor's vertical sync.
2. Move away any objects, such as another monitor or fan, that may be creating a magnetic field around the display.
3. Make sure your video card's output frequencies are supported by this monitor.

The screen seems to be constantly wavering.

1. If the monitor is close to another monitor, the adjacent monitor may need to be turned off. Fluorescent lights adjacent to the monitor may also cause screen wavering.

Power Supply

When the computer is turned on, nothing happens.

1. Check that one end of the AC power cord is plugged into a live outlet and the other end properly plugged into the back of the system.
2. Make sure that the voltage selection switch on the back panel is set for the correct type of voltage you are using.
3. The power cord may have a "short" or "open". Inspect the cord and install a new one if necessary.

Floppy Drive

The computer cannot access the floppy drive.

1. The floppy diskette may not be formatted. Format the diskette and try again.
2. The diskette may be write-protected. Use a diskette that is not write-protected.
3. You may be writing to the wrong drive. Check the path statement to make sure you are writing to the targeted drive.
4. There is not enough space left on the diskette. Use another diskette with adequate storage space.

Hard Drive

Hard disk failure.

1. Make sure the correct drive type for the hard disk drive has been entered in the BIOS.
2. If the system is configured with two hard drives, make sure the bootable (first) hard drive is configured as Master and the second hard drive is configured as Slave. The master hard drive must have an active/bootable partition.

Excessively long formatting period.

1. If your hard drive takes an excessively long period of time to format, it is likely a cable connection problem. However, if your hard drive has a large capacity, it will take a longer time to format.

Parallel Port

The parallel printer doesn't respond when you try to print.

1. Make sure that your printer is turned on and that the printer is on-line.
2. Make sure your software is configured for the right type of printer attached.
3. Verify that the onboard LPT port's I/O address and IRQ settings are configured correctly.
4. Verify that the attached device works by attaching it to a parallel port that is working and configured correctly. If it works, the printer can be assumed to be in good condition. If the printer remains inoperative, replace the printer cable and try again.

Serial Port

The serial device (modem, printer) doesn't output anything or is outputting garbled characters.

1. Make sure that the serial device's power is turned on and that the device is on-line.
2. Verify that the device is plugged into the correct serial port on the rear of the computer.
3. Verify that the attached serial device works by attaching it to a serial port that is working and configured correctly. If the serial device does not work, either the cable or the serial device has a problem. If the serial device works, the problem may be due to the onboard I/O or the address setting.
4. Make sure the COM settings and I/O address are configured correctly.

Keyboard

Nothing happens when a key on the keyboard was pressed.

1. Make sure the keyboard is properly connected.
2. Make sure there are no objects resting on the keyboard and that no keys are pressed during the booting process.

System Board

1. Make sure the add-in card is seated securely in the expansion slot. If the add-in card is loose, power off the system, re-install the card and power up the system.
2. Check the jumper settings to ensure that the jumpers are properly set.
3. Verify that all memory modules are seated securely into the memory sockets.
4. Make sure the memory modules are in the correct locations.
5. If the board fails to function, place the board on a flat surface and seat all socketed components. Gently press each component into the socket.
6. If you made changes to the BIOS settings, re-enter setup and load the BIOS defaults.