



## Electronic Emission Notices

### Federal Communications Commission (FCC) Statement (007828)

This equipment has been tested and found to comply with the limits for a Class B digital device, pursuant to Part 15 of FCC Rules. These limits are designed to provide reasonable protection against harmful interference in a residential installation. This equipment generates, uses and can radiate radio frequency energy and, if not installed and used in accordance with instructions contained in this manual, may cause harmful interference to radio and television communications. However, there is no guarantee that interference will not occur in a particular installation.

If this equipment does cause harmful interference to radio or television reception, which can be determined by turning the equipment off and on, the user is encouraged to try to correct the interference by one or more of the following measures:

- REORIENT OR RELOCATE THE RECEIVING ANTENNA
- INCREASE THE SEPARATION BETWEEN THE EQUIPMENT AND THE RECEIVER
- CONNECT THE EQUIPMENT INTO AN OUTLET ON A CIRCUIT DIFFERENT FROM THAT OF THE RECEIVER
- CONSULT THE DEALER OR AN EXPERIENCED AUDIO/TELEVISION TECHNICIAN

**NOTE:** Connecting this device to peripheral devices that do not comply with Class B requirements, or using an unshielded peripheral data cable, could also result in harmful interference to radio or television reception.

The user is cautioned that any changes or modifications not expressly approved by the party responsible for compliance could void the user's authority to operate this equipment.

To ensure that the use of this product does not contribute to interference, it is necessary to use shielded I/O cables.

### Copyright

This manual is copyrighted with all rights reserved. No portion of this manual may be copied or reproduced by any means.

While every precaution has been taken in the preparation of this manual, no responsibility for errors or omissions is assumed. Neither is any liability assumed for damages resulting from the use of the information contained herein.

### Trademarks

All brand names, logos and registered trademarks mentioned are property of their respective owners.

---

## Table of Contents

|  |           |
|--|-----------|
| <b>HARDWARE CONFIGURATION</b> .....                              | <b>3</b>  |
| Key Features .....   | 3         |
| Motherboard Layout .....   | 5         |
| Jumper Settings .....  | 6         |
| CPU Speed Selection .....  | 6         |
| JP1 - System Bus Frequency(only for 845G) .....                  | 6         |
| JP2 - CMOS Clear .....   | 6         |
| JP5 - Keyboard Power Select .....                                | 6         |
| JP6 - On Board AC97 Codec Sound .....                            | 6         |
| SW1 - Code to Voltage Definition .....                           | 7         |
| Pin Assignment .....   | 8         |
| <b>HARDWARE SETUP</b> .....                                      | <b>9</b>  |
| To Install DDR DIMMs .....                                       | 9         |
| Installing a New Processor .....                                 | 10        |
| To Install a Processor to ZIF Socket .....                       | 10        |
| Connect the Processor Fan Connector .....                        | 10        |
| Setting the Processor Speed .....                                | 10        |
| <b>BIOS SETUP</b> .....  | <b>11</b> |
| Starting Setup .....   | 11        |
| Main Menu .....  | 12        |
| Standard CMOS Features .....                                     | 13        |
| Advanced BIOS Features .....                                     | 15        |
| Advanced Chipset Features .....                                  | 15        |
| Integrated Peripherals .....                                     | 15        |
| Power Management Setup .....                                     | 15        |
| PNP/PCI Configurations .....                                     | 15        |
| PC Health Status .....   | 15        |
| Frequency/Voltage Control .....                                  | 15        |
| Set Supervisor/User Password .....                               | 16        |
| Flash Update Procedure .....                                     | 17        |
| <b>APPENDIX</b> .....  | <b>18</b> |
| AC97 Sound Driver Installation for Windows NT 4.0/2000/XP .....  | 18        |
| Onboard VGA Driver Installation for Windows NT 4.0/2000/XP ..... | 18        |
| USB 2.0 Driver Installation for Windows 9X .....                 | 18        |

---

## HARDWARE CONFIGURATION

### Key Features :

#### Chipset

- Intel® Brookdale-G/GL(845G/GL) Chipset.

#### Processor

- Supports the Intel® Pentium® 4 processors and the Northwood processors in the 478-pin package.
- Supports PSB (Processor System Bus) frequency of 400MHz (100MHz bus clock).
- Supports PSB (Processor System Bus) frequency of 533MHz (133MHz bus clock) (only for 845G).

#### VRM 9.0 (Voltage Regulator Modules) on Board

- Flexible motherboard design with on board VRM 9.0, easy to upgrade with future Intel® Pentium® 4 and Northwood processors.

#### Cache

- The Intel® Pentium® 4 and Northwood processors built-in L2 Cache.

#### System Memory

- Up to 2.0 Gbytes of 200MHz or 266MHz DDR SDRAM.
- Supports up to two DDR DIMMs, single-sided or double-sided.
- Supports DDR200/266 unregistered, 184-pin non-ECC DDR SDRAM DIMMs.
- Does not support double-sided x16 DDR DIMMs.

#### AGP Controller (only for 845G)

- Supports AGP2.0 including 1x/2x/4x AGP data transfers and 2x/4x Fast Write protocol.
- AGP 1.5V connector support only, No support for 3.3V or Universal AGP connectors.
- High priority access support.
- Delayed transaction support for AGP reads that cannot be serviced immediately.

#### On-board I/O

- On board two PCI fast IDE ports supporting up to 4 ATA, ATA2 , Ultra ATA33/66/100 IDE HDDs, CD-ROMs, ZIP drives and LS-120 drives as boot drive.
- One ECP/EPP parallel port.
- Two 16550 Compatible UART serial ports.
- One floppy port supports two FDD of 360KB, 720KB, 1.2MB , 1.44MB and 2.88MB capacity.
- PS/2 keyboard connector.
- PS/2 mouse is supported.
- One front panel sound connector.
- Infrared (IrDA) is supported via a header.

#### Expanded USB Support

- Includes 3 UHCI host controllers, increasing the number of external ports to six.
- Includes 1 EHCI USB2.0 Host Controller that supports all six ports (Bandwidth shared between six ports).

### **On-board VGA**

- Core Frequency of 200MHz.
- 3D Setup Render Engine.
- High Quality Texture Engine.
- 3D Graphics Rasterization Enhancements.
- Full 2D H/W Acceleration.
- Motion Video Acceleration.
- Up to 1600x1200 in 8 bit Color at 85MHz Refresh.
- H/W Motion Compensation Assistance for S/W MPEG2 Decode.
- Software DVD at 30fps.
- Integrated 24-bit 230MHz RAMDAC.

### **System BIOS**

- PnP, APM, ATAPI and Windows 95/98/2000.
- Full support of ACPI & DMI.
- Auto detects and supports LBA harddisks with capacities over 8.4GB.
- Easy to upgrade BIOS by end-user.

### **Plug and Play**

- Supports Plug and Play specification 1.1.
- Plug and play for DOS, Windows 3.X, Windows 95/98/2000, as well as Windows XP.
- Fully steerable PCI interrupts.

### **Power Management**

- Supports SMM, APM and ACPI.
- Break switch for instant suspend/resume on system operations.
- Energy star "Green PC" compliant.
- Hardware monitoring circuit is supported, provide voltage, fan speed, etc. monitoring (optional).
- WOL (Wake-On-Lan) Header support.
- External Modem Ring-in Wake-up support.
- Supports suspend-to-RAM(STR)(optional).

### **On-board AC97 Sound**

- Integrated AC97 controller with standard AC97 Codec.
- Direct Sound and Sound Blaster compatible.
- Full-Duplex 16-bit record and play back.
- PnP and APM 1.2 support.
- Win@ 95/98/2000/XP, NT drivers ready.
- Line-in, Line-out, Mic-in and MIDI/Game port.
- Support six sound channel output (optional).

### **Expansion Slots**

- 1 CNR slot (shares 1 PCI slot) (optional).
- 1 AGP slot (845GL supports ADD card only, 845G supports ADD card)(optional).
- 6 PCI bus master slots - ver. 2.1 compliant (1 PCI shares with 1 CNR slot).

#### **CAUTION**

Static electricity can harm delicate components of the motherboard. To prevent damage caused by static electricity, discharge the static electricity from your body before you touch any of the computers electronic components.

## Motherboard Layout

The following diagrams show the relative positions of the jumpers, connectors, major components and memory banks on the motherboard.

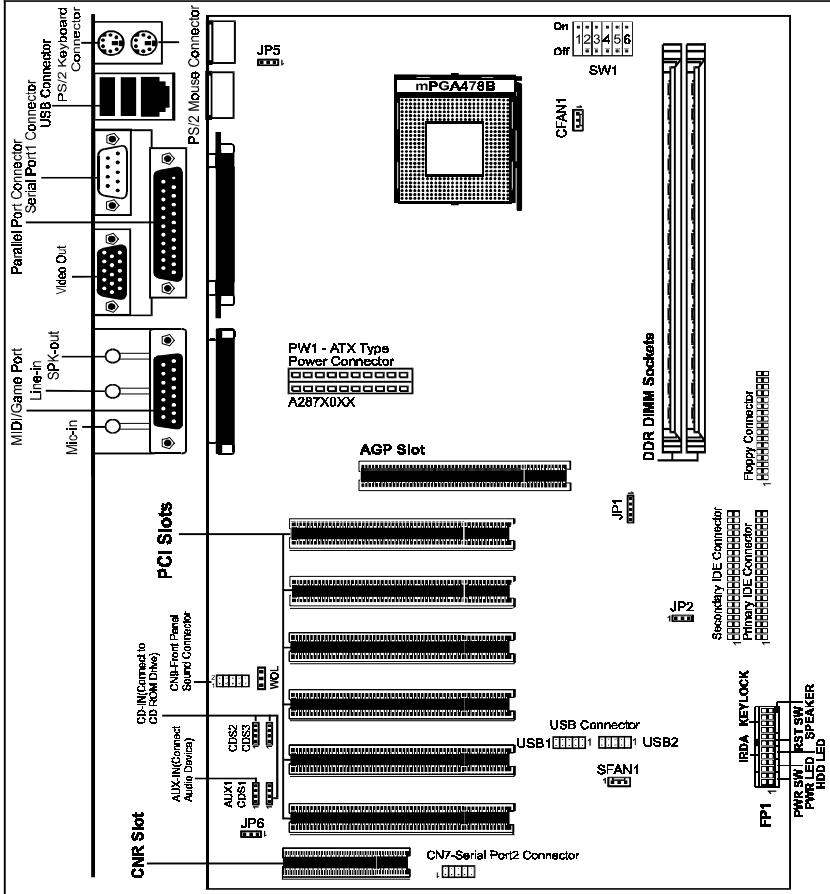

# JP1 is only for 845G.

# AGP Slot (845GL supports ADD card only, 845G supports ADD card)(optional).

### NOTE

- 1) Be sure to check the cable orientation in order to match the colored strip to the pin 1 end of the connector.
- 2) When you start up the system, please wait for 5 seconds after you power on AC.
- 3) It is not recommended to add a metal spacer plate on the back of the Socket478. Otherwise, some components will be short and damaged.

## Jumper Settings

This chapter explains how to configure the motherboard's hardware. Before using your computer, make sure all jumpers and DRAM modules are set correctly. Refer to this chapter whenever in doubt.

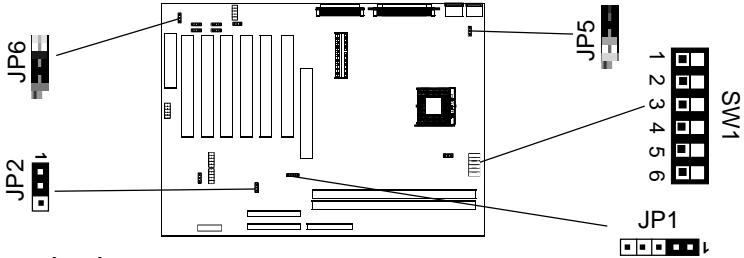

### CPU Speed Selection

In this motherboard, jumperless feature is implemented such that no jumper is required to be set for different type of CPU installed.

#### Notice:

1. Be sure to save the CMOS setting when exit the CMOS.
2. The CPU is frequency multiplier locked, no CPU speed change will be seen even if the frequency multiplier setting in CMOS setup is changed.

### JP1 – System Bus Frequency (only for 845G)

| JP1                    | CPU Clock Speed |
|------------------------|-----------------|
| 1 [●] [●] [●] [●] 1-2* | Auto*           |
| 1 [●] [●] [●] [●] 3-4  | 133MHz          |
| 1 [●] [●] [●] [●] 4-5  | 100MHz          |

### JP2 – CMOS Clear

| JP2                | Selection  |
|--------------------|------------|
| 1 [●] [●] [●] 1-2* | Normal*    |
| 1 [●] [●] [●] 2-3  | CMOS Clear |

### JP5 – Keyboard Power Select

| JP5                | Select                 |
|--------------------|------------------------|
| 1 [●] [●] [●] 2-3* | Powered by +5V*        |
| 1 [●] [●] [●] 1-2  | Powered by +5V Standby |

### JP6 – On Board AC97 Codec Sound

| JP6                | Function           |
|--------------------|--------------------|
| 1 [●] [●] [●] 2-3  | AC97 Sound Disable |
| 1 [●] [●] [●] 1-2* | AC97 Sound Enable* |





















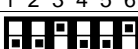

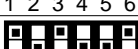

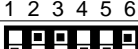
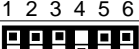
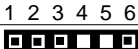

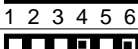
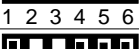
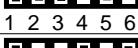
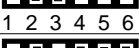
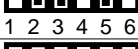

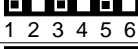
Close



Open

\* = Default setting.

## SW1 – Code to Voltage Definition

| SW1[1:6]   | VCC_CORE | SW1[1:6]   | VCC_CORE |
|--|----------|--|----------|
| <br>1 2 3 4 5 6   | Off      | <br>1 2 3 4 5 6   | 1.500    |
| <br>1 2 3 4 5 6   | 1.100    | <br>1 2 3 4 5 6   | 1.525    |
| <br>1 2 3 4 5 6   | 1.125    | <br>1 2 3 4 5 6   | 1.550    |
| <br>1 2 3 4 5 6   | 1.150    | <br>1 2 3 4 5 6   | 1.575    |
| <br>1 2 3 4 5 6   | 1.175    | <br>1 2 3 4 5 6   | 1.600    |
| <br>1 2 3 4 5 6   | 1.200    | <br>1 2 3 4 5 6   | 1.625    |
| <br>1 2 3 4 5 6   | 1.225    | <br>1 2 3 4 5 6   | 1.650    |
| <br>1 2 3 4 5 6   | 1.250    | <br>1 2 3 4 5 6   | 1.675    |
| <br>1 2 3 4 5 6   | 1.275    | <br>1 2 3 4 5 6   | 1.700    |
| <br>1 2 3 4 5 6   | 1.300    | <br>1 2 3 4 5 6   | 1.725    |
| <br>1 2 3 4 5 6   | 1.325    | <br>1 2 3 4 5 6   | 1.750    |
| <br>1 2 3 4 5 6   | 1.350    | <br>1 2 3 4 5 6   | 1.775    |
| <br>1 2 3 4 5 6  | 1.375    | <br>1 2 3 4 5 6  | 1.800    |
| <br>1 2 3 4 5 6 | 1.400    | <br>1 2 3 4 5 6 | 1.825    |
| <br>1 2 3 4 5 6 | 1.425    | <br>1 2 3 4 5 6 | 1.850    |
| <br>1 2 3 4 5 6 | 1.450    | <br>1 2 3 4 5 6 | Auto*    |
| <br>1 2 3 4 5 6 | 1.475    |  |          |

 On  Off \* =Auto.

# Pin Assignment

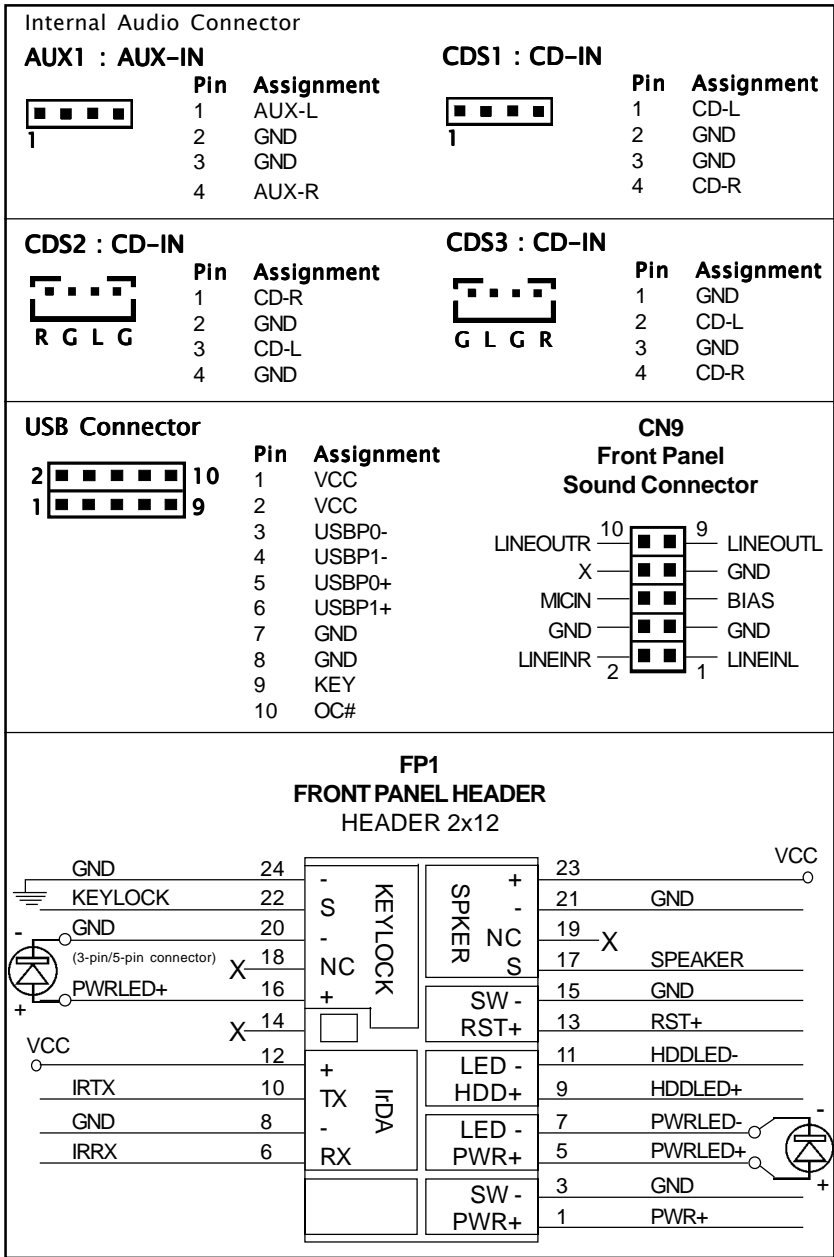

## Hardware Setup

### To Install DDR DIMMs

1. Locate the DDR DIMM sockets.
2. Holding the DDR DIMM by the edges, remove it from its antistatic package.
3. Make sure the clips at either end of the socket are pushed away from the socket.

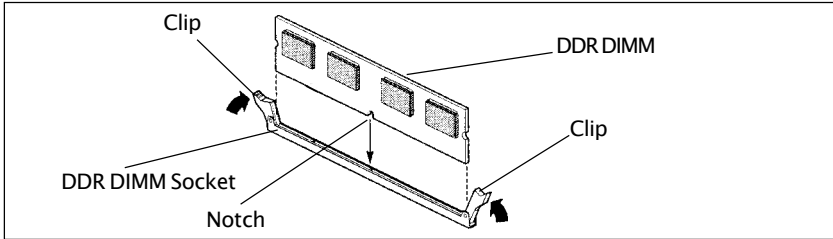

4. Position the DDR DIMM above the socket. Align the two small notches in the bottom edge of the DDR DIMM with the keys in the socket.
5. Insert the bottom edge of the DDR DIMM into the socket.
6. When the DDR DIMM is seated, push down on the top edge of the DDR DIMM until the retaining clips at the ends of the socket snap into place. Make sure the clips are firmly in place.



**Please turn off system before installing and removing any device, otherwise you'll cause the system damage.**

## Installing a New Processor

An upgrade processor can dramatically increase general system speed and performance.

Most microprocessor upgrade kits include the following items:

- Microprocessor chip
- Installation instructions and technical data

***Before installing the processor, please refer to the installation notes that available with the CPU package.***

## To Install a Processor to ZIF Socket

To install the processor, follow these steps:

1. If the system microprocessor is already on the motherboard socket, you need to remove it from the motherboard socket. The socket is a Zero Insertion Force (ZIF) socket which has a metal arm at one side. Carefully grasp this arm, move it horizontally away from the socket and lift it up. Eventually you will be able to lift the chip straight up out of the socket. Be careful not to bend any pins.

***Be careful not to bend any of the pins when removing the microprocessor chip from its socket. The microprocessor chip can be permanently damaged.***

2. Unpack the new microprocessor chip.
3. Carefully align the processor with the correct orientation to the socket on the motherboard.
4. Carefully insert the processor into the socket, and move the metal arm downward to replace it in its original position.

## Connect the Cooling Fan Connector

The CPU should always have a Heat Sink and cooling fan attached to prevent overheating.

Please follow the setup to install the Heat Sink and cooling fan. Then connect the processor fan cable to the fan connector that located on the motherboard near the processor and ensure the fan can operate. Otherwise the CPU can overheat and cause ***damage to both CPU and motherboard.***

## Setting the Processor Speed

After you install the processor into the motherboard, set the processor speed by CMOS setup.

## BIOS Setup

This chapter discusses Award's Setup Program built into the ROM BIOS. The Setup Program allows users to modify the basic system configuration. This special information is then stored in battery-backed RAM, which retains the setup information when the power is turned off.

### Starting Setup

The Award BIOS is immediately activated when you turn on the computer. The BIOS reads the system information contained in the CMOS and begins the process of checking out the system and configuring it. When it finishes, the BIOS will seek an operating system on one of the disks and then launch and turn control over to the operating system.

While the BIOS is in control, the Setup Program can be activated :

1. By pressing <Del> immediately after switching the system on, or
2. By pressing the <Del> key when the following message appears briefly at the bottom of the screen during the POST (Power On Self Test )

#### ***Press DEL to enter SETUP***

If the message disappears before you can respond and you still wish to enter Setup, restart the system to try again by turning it OFF then ON or pressing the "RESET" button on the system case. You may also restart by simultaneously pressing the <Ctrl>, <Alt>, and <Delete> keys. If you do not press the keys at the correct time and the system does not reset, an error message will be displayed and you will again be asked to ...

#### ***PRESS F1 TO CONTINUE, DEL TO ENTER SETUP***

### Getting Help

Press F1 to pop up a small help window that describes the appropriate keys to use and the possible selections for the highlighted item. To exit the Help Window press <Esc> or the F1 key again.

### In Case of Problems

If, after making and saving system changes with the Setup Program, you discover that your computer does not reset, use the Award BIOS defaults to override the CMOS settings.

**Main Menu**

Once you enter the Award BIOS CMOS Setup Utility, the Main Menu will appear on the screen. The Main Menu allows you to select from various setup functions and two exit choices. Use the arrow keys to select among the items and press <Enter> to accept and enter the sub-menu.

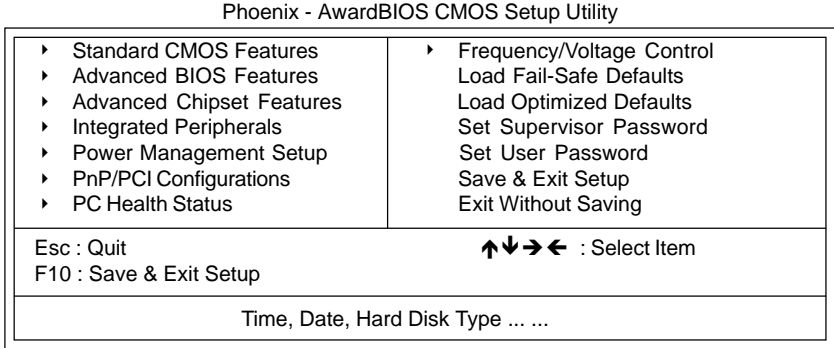

**(Note : The figures of BIOS Setup Menu included here only show a typical case, and may not be exactly the same as the one on your unit.)**

Note that a brief description of each highlighted item will appear at the bottom of the screen.

**Standard CMOS Features** This setup page includes all the items of Award™ special standard features.

**Advanced BIOS Features** This setup page includes all the items of Award™ special enhanced features.

**Advanced Chipset Features** This setup page includes all the items of chipset special features.

**Integrated Peripherals** This section page includes all the items of IDE hard drive and Programmed Input / Output features.

**Power Management Setup** This entry only appears if your system supports Power Management “Green PC” standards.

**PNP/PCI Configurations** This entry appears if your system supports PNP/PCI.

**PC Health Status** Display CPU and Case Fan Speed.

**Frequency/Voltage Control** CPU speed setting are settings of CPU speed. You should refer to your CPU marking.

**Load Fail-Safe Defaults** The BIOS defaults have been set by the manufacturer and represent settings which provide the minimum requirements for your system to operate.

**Load Optimized Defaults** The chipset defaults are settings which provide for maximum system performance. While Award has designed the custom BIOS to maximize performance, the manufacturer has the right to change these defaults to meet its needs.

**Set Supervisor/User Password** Changes, sets, or disables password. It allows you to limit access to the system and the Setup Program.

**Save & Exit Setup** Saves value changes to CMOS and exits setup.

**Exit Without Saving** Abandons all CMOS value changes and exits setup.

## Standard CMOS Features

The items in Standard CMOS Setup Menu are divided into 10 categories. Each category includes one or more setup items. Use the arrow keys to highlight the item and then use the <PgUp> or <PgDn> key to select the desired value in each item.

### Phoenix - AwardBIOS CMOS Setup Utility Standard CMOS Features

|                        |                       |   |
|------------------------|-----------------------|---|
| Date (mm :dd :yy)      | Mon. May 21 2001      | Item Help                               |
| Time (hh :mm:ss)       | 11 : 1 : 35           |   |
| ▶ IDE Primary Master   | [Press Enter 4303 MB] | Menu Level ▶                            |
| ▶ IDE Primary Slave    | [None]                | Change the day, month, year and century |
| ▶ IDE Secondary Master | [None]                |   |
| ▶ IDE Secondary Slave  | [None]                |   |
| Drive A                | [1.44M, 3.5 in.]      |   |
| Drive B                | [None]                |   |
| Video                  | [EGA/VGA]             |   |
| Halt on                | [All, but keyboard]   |   |
| Base Memory            | 640K                  |   |
| Extended Memory        | 30720K                |   |
| Total Memory           | 31744K                |   |

↑↓→←Move Enter: Select +/-/PU/PD : Value F10 : Save ESC : Exit F1 :General Help  
F5 : Previous Values F6 : Fail-Safe Defaults F7 : Optimized Defaults

**(Note : The figures of BIOS Setup Menu included here only show a typical case, and may not be exactly the same as the one on your unit.)**

|  |   |
|--|---|
| <b>Date</b>  | The date format is <day-of-the-week>. <month> <day> <year>.   |
| <b>Time</b>  | The time format is <hour> <Minute> <second> displayed in 24-hour military-time clock. For example, 1 p. m. is displayed as 13:00:00.  |
| <b>Primary<br/>Master/Primary<br/>Slave/Secondary<br/>Master/Secondary</b> | These categories identify the types of the two channels that have been installed in the computer.<br>If the controller of the HDD interface is SCSI, the selection shall be "None". |
| <b>Drive A Type /<br/>Drive B Type</b>                                     | This category identifies the types of floppy disk drive A or drive B that has been installed in the computer.   |
| <b>Video</b>   | The default setting is EGA/VGA.   |
| <b>Halt on</b>   | You can select which type of error will cause the system to halt.   |

## **Advanced BIOS Features**

This section allows you to configure your system for basic operation. You have the opportunity to select the system's default speed, boot-up sequence, keyboard operation, shadowing and security.

## **Advanced Chipset Features**

The Chipset Features Setup option is used to change the values of the chipset registers. These registers control most of the system options in the computer.

This section allows you to configure the system based on the specific features of the installed chipset. This chipset manages bus speeds and access to system memory resources, such as DRAM and the external cache. It must be stated that these items should not be altered. The default settings have been chosen because they provide the best operating conditions for your system.

## **Integrated Peripherals**

The Integrated Peripherals Setup allows the user to configure the onboard IDE controller, floppy disk controller, the printer port and the serial ports.

## **Power Management Setup**

The Power Management Setup Menu allows you to configure your system to most save energy while operating in a manner consistent with your own style of computer use.

## **PNP/PCI Configurations**

This section describes how to configure the PCI bus system. This section covers some very technical items and it is recommended that only experienced users should make any changes to the default settings.

## **PC Health Status**

The PC Health Status display CPU and Case Fan Speed.

## **Frequency/Voltage Control**

This section allows you to set CPU Speed.

## Set Supervisor/User Password

You can set either supervisor or user password, or both of them. The difference between them are:

**Supervisor Password :** You can enter the Setup Program and change the options of the setup menus.

**User Password :** You can enter the Setup Program but can not change the options of the setup menus.

When you select this function, the following message will appear at the center of the screen to assist you in creating a password.

### ***ENTER PASSWORD:***

Type the password, up to eight characters in length, and press<Enter>. The new password will clear the previously entered password from the CMOS memory. You will be asked to confirm the password. Type the password again and press <Enter>. You may also press <Esc> to abort the selection and operate without a password.

To disable a password, just press <Enter> when you are prompted to enter the password. A message will be displayed to confirm that the password is disabled.

### ***PASSWORD DISABLED.***

Once the password is disabled, the system will reset and you can enter the Setup Program freely.

When a password is enabled, you will be prompted to enter it every time you try to enter setup. This prevents an unauthorized person from changing any setting of your system configuration.

In addition, when a password is enabled, you can require the BIOS to request a password every time your system is rebooted. This would further prevent unauthorized use of your computer.

The password requirement is defined by the Security Option of the BIOS Features Setup Menu. If the Security Option is set to "System", the password will be required both at resetting and at entering setup. If the option is set to "Setup", the prompt only appears when you try to enter setup.

---

## Flash Update Procedure

A program AWDFLASH.EXE is included in the utility diskette or CD (X:\Utility\AWDFLASH.EXE). The user is recommended to follow the procedure below to update the flash BIOS.

(X: your CD driver letter).

1. Create a DOS-bootable floppy diskette. Copy the new BIOS file (just obtained or downloaded) and the utility program AWDFLASH.EXE to the diskette.
2. Allow the PC system to boot from the DOS diskette.
3. At the DOS prompt, key in

**AWDFLASH**  
**and hit <ENTER>**

4. Enter the file name of the new BIOS.
5. The question: "Do you want to save BIOS (Y/N)?" is displayed.

**Key in "N" if there is no need to save the existing BIOS content..**  
**Key in "Y" if a backup copy of the existing BIOS is needed.**  
**(A file name has to be assigned to the existing BIOS binary file.)**

6. The question : "Are you sure to program (Y/N)?" is displayed.

**Key in "Y"**

7. Wait until the flash-update is completed.
8. Power down the PC system.
9. Restart the PC.

### **Warning:**

DO not turn off or RESET the computer during the flash process.

If you are unsure how to upgrade the BIOS, it is best to take your computer to an Authorized Service Center and have a trained technician do the work for you.

## APPENDIX

### AC97 Sound Driver Installation for Windows NT4.0/2000/XP/9X

Please follow the step to install AC97 Sound Driver for Windows NT 4.0/2000/XP.

*(Note : This manual assumes that your CD-ROM device drive letter is D:.)*  
D:\Intel Chipset\AC97Sound\ALC20X\

### Onboard VGA Driver Installation for Windows NT 4.0/2000/XP

Please follow the step to install Onboard VGA Driver for Windows NT 4.0/2000/XP.

*(Note : This manual assumes that your CD-ROM device drive letter is D:.)*

Windows NT 4.0 - D:\Intel Chipset\VGA\_845G\Winnt4\Graphics\

Windows 2000 - D:\Intel Chipset\VGA\_845G\Win2k\_xp\Graphics\

Windows XP - D:\Intel Chipset\VGA\_845G\Win2k\_xp\Graphics\

### USB 2.0 Driver Installation for Windows 9X

USB 2.0 Support for Win9X

Up to now, only Windows XP and Win2000 can support the USB 2.0 feature for Intel chipset. If you are running the Windows 9X O.S., you can refer to the following steps to remove the yellow bang.

*(Note : This manual assumes that your CD-ROM device drive letter is D:.)*

1. Open the MS-DOS prompt.
2. Locate the directory of CD drive:  
D:\Intel chipset\InF\_install
3. Run the command: "Setup -USB2".
4. Follow the instruction to finish the installation.



